



Movel
do Brasil

SINCE 2012



CATÁLOGO DE PRODUTOS 2026



8 Cores Disponíveis

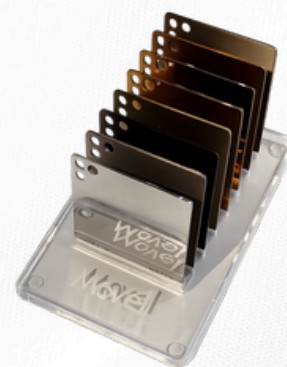
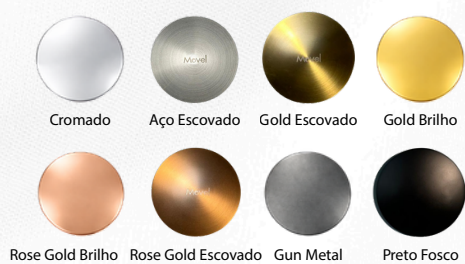

Quem somos?

Na união entre paixão e inovação, nasceu a Movell do Brasil. Presente no mercado desde 2012, a marca vem se consolidando como uma das principais referências do segmento, oferecendo produtos que aliam qualidade, confiança e design.

Nosso propósito é apresentar um novo conceito em louças, metais, banheiras, cubas de inox e cubas de concreto, com ampla diversidade de cores e estilos, desenvolvidos para atender às mais variadas necessidades dos projetos contemporâneos.

-  (48) 9 9663-0804
-  (48) 3442-5905
-  www.movellbrasil.com.br
-  contato@movellbrasil.com.br
-  @movellbrasil
-  Área Industrial 3, Lote 01, Quadra F
Rua Ambrósio Dallo, nº 3261 - Cocal do Sul/ SC



Há 14 anos no mercado, a Movêl do Brasil apresenta o Catálogo 2026, com soluções que unem design, funcionalidade e qualidade.

Cada produto é desenvolvido com materiais de alto padrão e atenção aos detalhes, acompanhando as tendências e as necessidades dos ambientes contemporâneos.

Com foco na durabilidade, no conforto e na sofisticação, oferecemos um portfólio pensado para transformar espaços e valorizar o dia a dia. Conte com a Movêl do Brasil para criar ambientes mais modernos, acolhedores e cheios de personalidade.

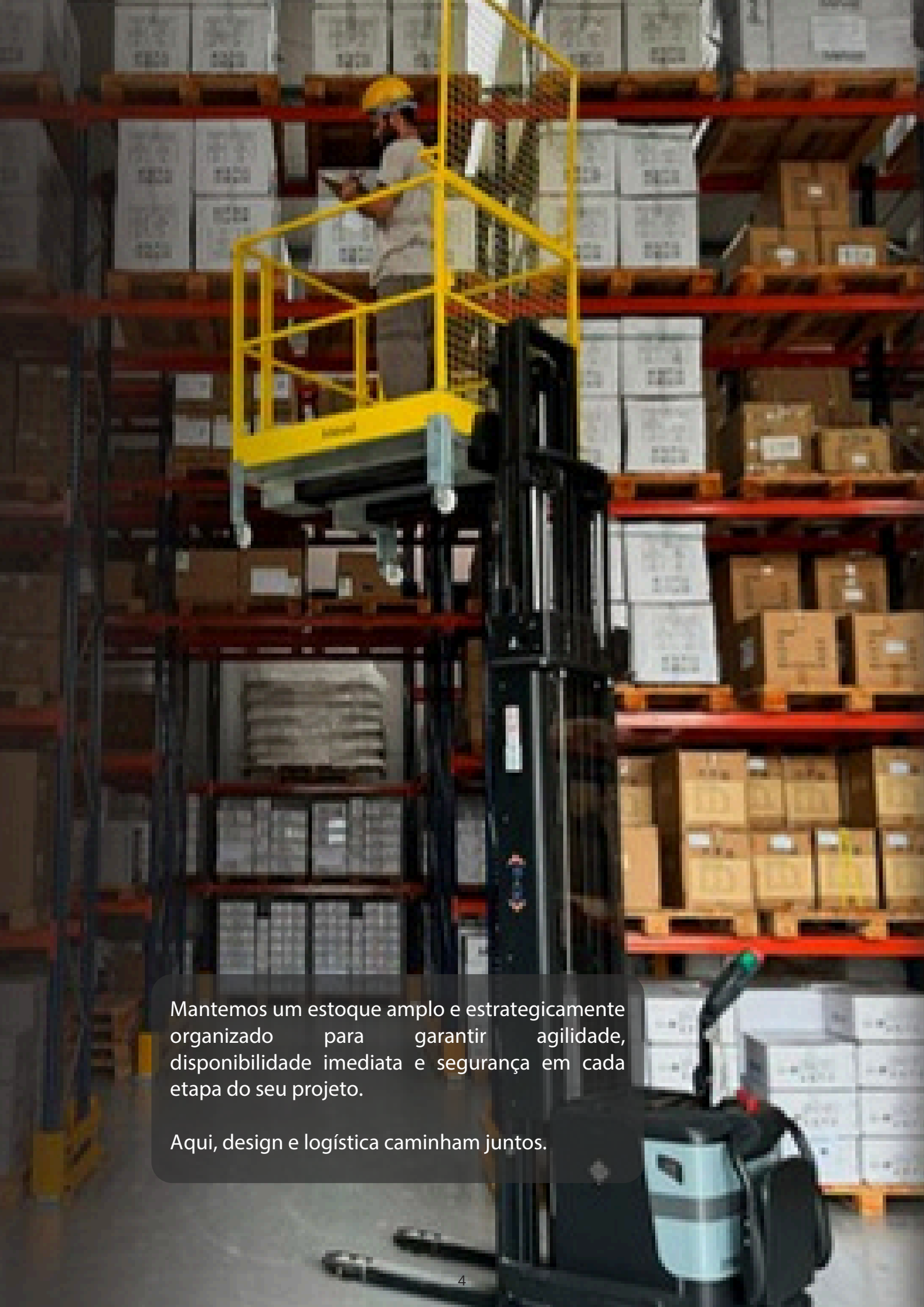
A worker wearing a yellow hard hat and a light-colored shirt is standing on a yellow scissor lift. The lift is positioned in a large warehouse with high, red metal shelving units. The shelves are filled with numerous cardboard boxes, some on pallets. The worker is looking down at a clipboard or document. The background shows the repetitive structure of the warehouse racks, creating a sense of depth and scale.

Mantemos um estoque amplo e estrategicamente organizado para garantir agilidade, disponibilidade imediata e segurança em cada etapa do seu projeto.

Aqui, design e logística caminham juntos.

Módulos de Exposição 2026





Jato superior tipo cascata

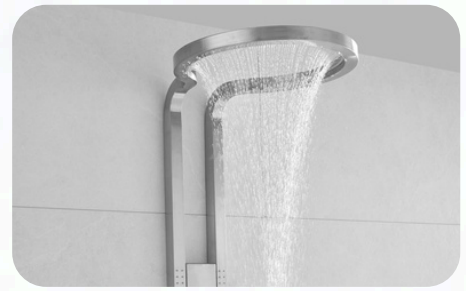

Jato superior para as costas

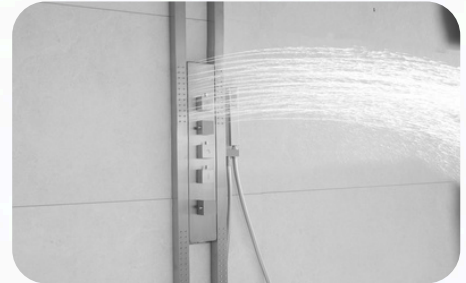

Jato inferior para as costas



Ducha de mão

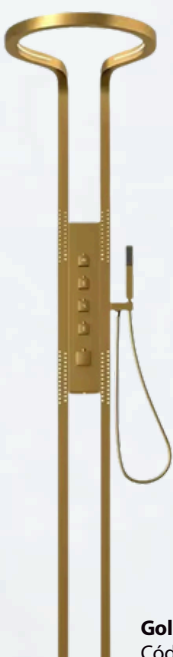

Gold Fosco
Cód : 111/545/001

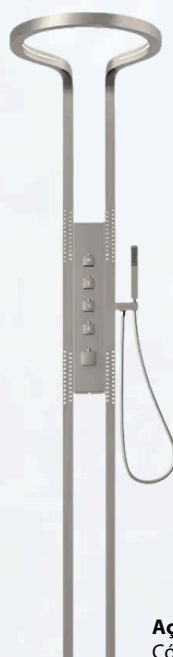

Aço Escovado
Cód : 111/545/002

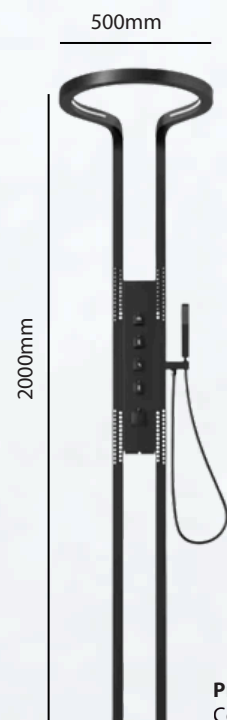

Preto Fosco
Cód : 111/545/003

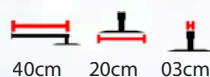

Pressão mínima: 2 MCA | Recomendada: a partir de 6 MCA | Pressão máxima: 40 MCA

Vazão 6MCA - 10 lts p/ min.



Cromado
Cód braço de teto: 109/001/008
Cód braço de parede: 109/002/008
Cód ducha (bojo): 109/003/008



Gold Brilho
Cód braço de teto: 109/001/011
Cód braço de parede: 109/002/011
Cód ducha (bojo): 109/003/011



Preto Fosco
Cód braço de teto: 109/001/010
Cód braço de parede: 109/002/010
Cód ducha (bojo): 109/003/010



Aço Escovado
Cód braço de teto: 109/001/009
Cód braço de parede: 109/002/009
Cód ducha (bojo): 109/003/009



Gold Escovado
Cód braço de teto: 109/001/012
Cód braço de parede: 109/002/012
Cód ducha (bojo): 109/003/012



Rose Gold Escovado
Cód braço de teto: 109/001/013
Cód braço de parede: 109/002/013
Cód ducha (bojo): 109/003/013



Porta Roupão



Papeleira



Porta Toalha de Rosto 30cm



Porta Toalha de Banho 60cm



Porta Toalha de Banho Duplo

PORTA ROUPÃO



Cód Cromado: 204/014/001
 Cód Preto Fosco: 204/014/002
 Cód Gold Brilho: 204/014/003
 Cód Gold Escovado: 204/014/005
 Cód Aço Escovado: 204/014/006
 Cód Rose Gold Escovado: 204/014/007

PAPELEIRA



Cód Cromado: 204/015/001
 Cód Preto Fosco: 204/015/002
 Cód Gold Brilho: 204/015/003
 Cód Gold Escovado: 204/015/005
 Cód Aço Escovado: 204/015/006
 Cód Rose Gold Escovado: 204/015/007

P. TOALHA DE ROSTO 30cm



Cód Cromado: 204/016/001
 Cód Preto Fosco: 204/016/002
 Cód Gold Brilho: 204/016/003
 Cód Rose Gold Escovado: 204/016/004
 Cód Gold Escovado: 204/016/005
 Cód Aço Escovado: 204/016/006

P. TOALHA DE BANHO 60cm



Cód Cromado: 204/017/001
 Cód Preto Fosco: 204/017/002
 Cód Gold Brilho: 204/017/003
 Cód Gold Escovado: 204/017/005
 Cód Aço Escovado: 204/017/006
 Cód Rose Gold Escovado: 204/017/007

P. TOALHA DE BANHO DUPLO 60cm



Cód Cromado: 204/018/001
 Cód Preto Fosco: 204/018/002
 Cód Gold Brilho: 204/018/003
 Cód Gold Escovado: 204/018/005
 Cód Aço Escovado: 204/018/006
 Cód Rose Gold Escovado: 204/018/007

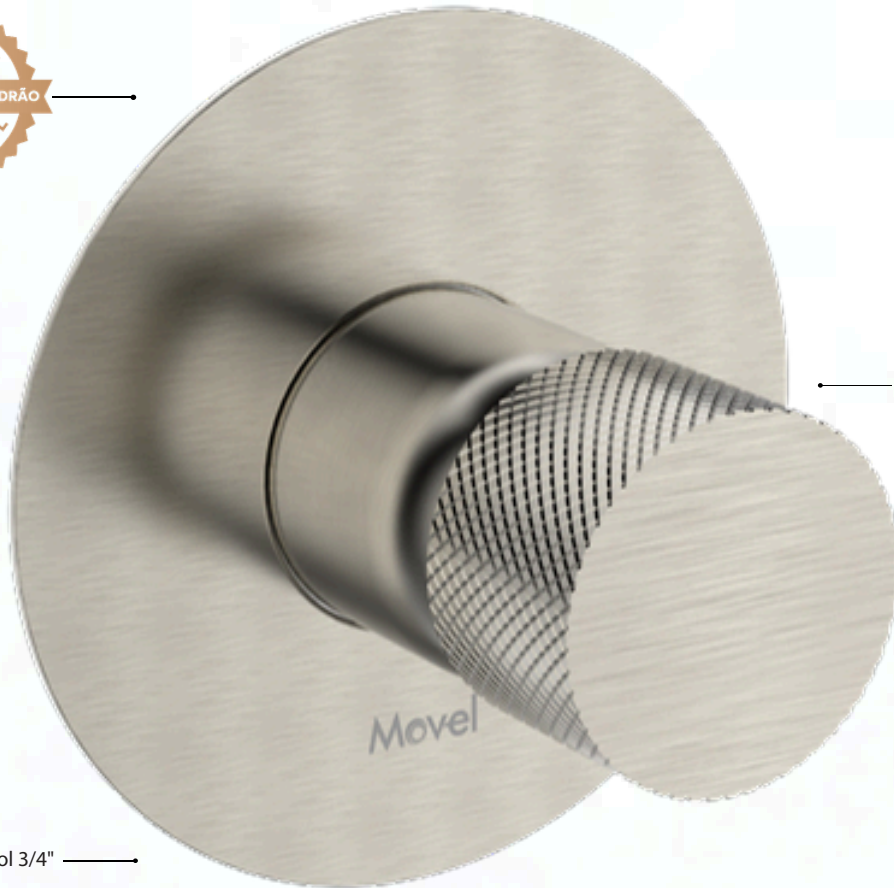

Controle o seu momento relaxante em um comando.

Transforme em M. DOCOL 3/4"

Possui Base Deca e Docol 3/4"

Acionamento e controle de temperatura intuitivo.

- Para Ducha Higiênica Base Deca > Adicionar Conversor : 805/011/011
- Para Monocomando Chuveiro Base Docol de 1/2" Transforme P/ Base Deca > Adicionar Kit Conversor: 805/002/001



Base Docol 3/4. (Bico Ferro)
Não existe conversor, Use acabamento Docol

Registro M. Docol 3/4". (Bico Plástico)

Para esse registro usar Acabamento Base Docol



Opção Para transformar seu Registro em Base Deca usando o conversor 805/002/001 + Acabamento Deca

Registro M. Docol 1/2 e 3/4". (Bico Plástico)

 cod: 805/054/002 Conversor P/ Registro Monocomando de Chuveiro 1/2 e 3/4 Docol P/ 3/4 Docol Plástico

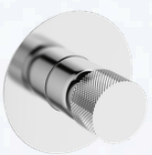

Cromado
Cód Base Deca: 122/545/001
Cód Base Docol: 127/545/001

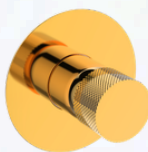

Gold Brilho
Cód Base Deca: 122/545/004
Cód Base Docol: 127/545/004

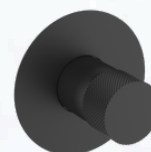

Preto Fosco
Cód Base Deca: 122/545/003
Cód Base Docol: 127/545/003

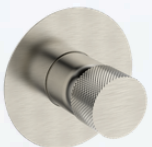

Aço Escovado
Cód Base Deca: 122/545/002
Cód Base Docol: 127/545/002

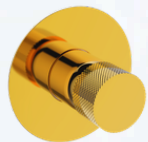

Gold Escovado
Cód Base Deca: 122/545/005
Cód Base Docol: 127/545/005

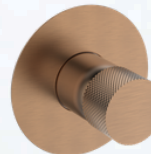

Rose Gold Escovado
Cód Base Deca: 122/545/006
Cód Base Docol: 127/545/006

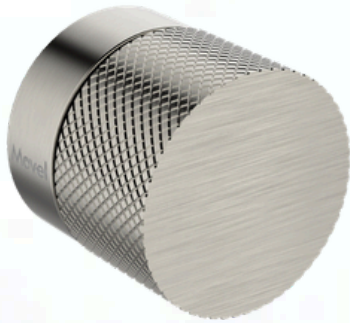

• Para Base Docol > Adicionar Conversor
> Cód Conversor Docol: 131623



• Para Base Fabrimar > Adicionar Conversor
> Cód Conversor Fabrimar: 132026

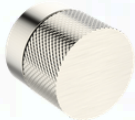

Cromado 3/4
Cód Deca: 123/545/001

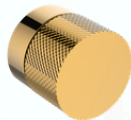

Gold Brilho 3/4
Cód Deca: 123/545/004

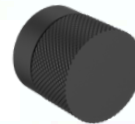

Preto Fosco 3/4
Cód Deca: 123/545/003

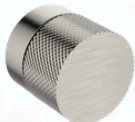

Aço Escovado 3/4
Cód Deca: 123/545/002

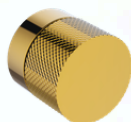

Gold Escovado 3/4
Cód Deca: 123/545/005

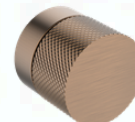

Rose Gold Escovado 3/4
Cód Deca: 123/545/006

Round

Ducha Higiênica



Com linhas curvas e proporções equilibradas, a **Ducha Round** traduz conforto visual e elegância atemporal, integrando-se com leveza a diferentes estilos de ambientes.

Comprimento flexível: 120cm.



Cromado
Cód Nias: 108/502/001



Gold Brilho
Cód Nias: 108/502/004



Preto Fosco
Cód Nias: 108/502/002



Rose Gold Brilho
Cód Nias: 108/502/003



Aço Escovado
Cód Nias: 108/502/007



Gold Escovado
Cód Nias: 108/502/005



Rose Gold Escovado
Cód Nias: 108/502/006

Pressão mínima: 4 MCA | Recomendada: a partir de 6 MCA | Pressão máxima: 40 MCA

Pressão - vazão 6MCA - 5 L/min

VÁLVULA CLICK (LATÃO) 1.1/4



- Acabamento em latão.
- Sistema de vedação em um toque.
- Escoamento de água eficaz.
- Design arredondado e elegante.

VÁLVULA CLICK ROUND 1.1/4

VÁLVULA CLICK PORCELANA 1.1/4



- Válvula aberta.
- Acabamento em porcelana.



Branco Brilho (Porcelana)
Cód Click: 210/502/006



Cromado
Cód Click : 210/502/001



Aço Escovado
Cód Click : 210/502/018



Branco Brilho
Cód Click : 210/502/005



Gold Brilho
Cód Click : 210/502/002



Gold Escovado
Cód Click: 210/502/016



Preto Fosco
Cód Click : 210/502/003



Rose Gold Brilho
Cód Click: 210/502/004



Rose Gold Escovado
Cód Click : 210/502/017



Tamanho Sifão Nias: 37x19x5cm

— Desenvolvido para compor o ambiente com elegância, o sifão une eficiência técnica a um design pensado para valorizar os detalhes visíveis do projeto.

— Previne vazamentos e impede o retorno de mau cheiro.



Cromado
Cód Nias: 106/502/001



Aço Escovado
Cód Nias: 106/502/007



Gold Brilho
Cód Nias: 106/502/004



Gold Escovado
Cód Nias: 106/502/005



Preto Fosco
Cód Nias: 106/502/002



Rose Gold Brilho
Cód Nias: 106/502/003



Rose Gold Escovado
Cód Nias: 106/502/006



Permita-se viver a melhor experiência.



Sistema Cold Start: Inicia o fluxo com água fria, acionando a água quente apenas com a rotação progressiva do comando.

Opção em bica baixa



26cm • 20cm • 21cm



19cm • 20cm • 14cm



Cromado
Cód Bica Alta: 706/545/001
Cód Bica Baixa: 705/545/001



Gold Brilho
Cód Bica Alta: 706/545/004
Cód Bica Baixa: 705/545/004



Preto Fosco
Cód Bica Alta: 706/545/002
Cód Bica Baixa: 705/545/002



Aço Escovado
Cód Bica Alta: 706/545/003
Cód Bica Baixa: 705/545/003



Gold Escovado
Cód Bica Alta: 706/545/005
Cód Bica Baixa: 705/545/005



Rose Gold Escovado
Cód Bica Alta: 706/545/006
Cód Bica Baixa: 705/545/006

Pressão mínima: 4 MCA | Recomendada: a partir de 6 MCA | Pressão máxima: 40 MCA

Furação 35mm - Pressão - vazão 6MCA - 5 lts p/ min.





Design minimalista slim.

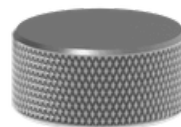

Mais eficiência: água fria na abertura, economia real de água e gás.



38cm • 25cm • 26cm

Liberdade de instalação: comando na base ou na lateral.



Furação 25/35mm - Pressão - vazão 6MCA - 5 lts p/ min.

Pressão mínima: 4 MCA | Recomendada: a partir de 6 MCA | Pressão máxima: 40 MCA



Cromado
Cód : 706/506/001



Aço Escovado
Cód : 706/506/007



Gold Brilho
Cód: 706/506/004



Gold Escovado
Cód: 706/506/005



Preto Fosco
Cód: 706/506/002



Rose Gold Brilho
Cód: 706/506/003



Rose Gold Escovado.
Cód: 706/506/006



Diversas opções de cores. —



•— Opção em bica baixa.



Pressão mínima: 4 MCA | Recomendada: a partir de 6 MCA | Pressão máxima: 40 MCA
 Furação 35mm - Pressão - vazão 6MCA - 5 lts p/ min.

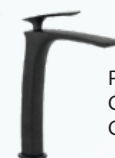

Preto Fosco
 Cód Bica Alta: 706/017/002
 Cód Bica Baixa: 705/017/002



Cromado
 Cód Bica Alta: 706/017/001
 Cód Bica Baixa: 705/017/001



Gold Brilho
 Cód Bica Alta: 706/017/004
 Cód Bica Baixa: 705/017/004



Rose Gold Brilho
 Cód Bica Alta: 706/017/003
 Cód Bica Baixa: 705/017/003



Aço Escovado
 Cód Bica Alta: 706/017/007
 Cód Bica Baixa: 705/017/007



Gold Escovado
 Cód Bica Alta: 706/017/005
 Cód Bica Baixa: 705/017/005



Rose Gold Escovado
 Cód Bica Alta: 706/017/006
 Cód Bica Baixa: 705/017/006



Disponível

- **Monocomando** (Quente e Frio)
- **1/4 de Volta** (Somente Água Fria)

Design geométrico que equilibra linhas retas com formas suavemente arredondadas, criando uma composição harmoniosa.



Pressão mínima: 4 MCA | Recomendada: a partir de 6 MCA | Pressão máxima: 40 MCA
Furação 35mm - Pressão - vazão 6MCA - 5 lts p/ min.



Cromado (Misturador)
Cód Bica Alta: 706/531/001
Cód Bica Baixa: 705/531/001



Cromado (1/4 Volta Fria)
Cód Bica Alta: 601/531/001
Cód Bica Baixa: 602/531/001



Gold Brilho (Misturador)
Cód Bica Alta: 706/531/004
Cód Bica Baixa: 705/531/004



Gold Brilho (1/4 Volta Fria)
Cód Bica Alta: 601/531/004
Cód Bica Baixa: 602/531/004



Preto Fosco (Misturador)
Cód Bica Alta: 706/531/003
Cód Bica Baixa: 705/531/003



Preto Fosco (1/4 Volta Fria)
Cód Bica Alta: 601/531/003
Cód Bica Baixa: 602/531/003



Gold Escovado (Misturador)
Cód Bica Alta: 706/531/005
Cód Bica Baixa: 705/531/005

Gold Escovado (1/4 Volta Fria)
Cód Bica Alta: 601/531/005
Cód Bica Baixa: 602/531/005



Rose Gold Escovado (Misturador)
Cód Bica Alta: 706/531/006
Cód Bica Baixa: 705/531/006

Rose Gold Escovado (1/4 Volta Fria)
Cód Bica Alta: 601/531/006
Cód Bica Baixa: 602/531/006

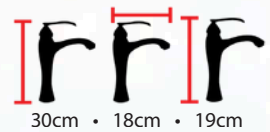

Preto Fosco
Cód Bica Alta: 706/008/004



Gold Brilho
Cód Bica Alta: 706/008/002



Cromado
Cód Bica Alta: 706/008/001



Gold Escovado
Cód Bica Alta: 706/008/005



Rose Gold Brilho
Cód Bica Alta: 706/008/003



21cm • 19cm • 14cm

Pressão mínima: 4 MCA | Recomendada: a partir de 6 MCA | Pressão máxima: 40 MCA
Furação 35mm - Pressão - vazão 6MCA - 5 lts p/ min.



Preto Fosco
Cód Bica Baixa: 705/020/004



Gold Brilho
Cód Bica Baixa: 705/020/002



Cromado
Cód Bica Baixa: 705/020/003



Gold Escovado
Cód Bica Baixa: 705/020/005



Rose Gold Brilho
Cód Bica Baixa: 705/020/001

Square Slim

Chuveiro de Parede | Parede com Desviador



40cm 20cm 03cm

Preto Fosco
Cód sem desviador: 110/521/002
Cód com desviador: 111/521/002



Cromado
Cód sem desviador: 110/521/001
Cód com desviador: 111/521/001



Gold Brilho
Cód sem desviador: 110/521/004
Cód com desviador: 111/521/004



Rose Gold Brilho
Cód sem desviador: 110/521/003
Cód com desviador: 111/521/003



Aço Escovado
Cód sem desviador: 110/521/006
Cód com desviador: 111/521/006



Gold Escovado
Cód sem desviador: 110/521/005
Cód com desviador: 111/521/005



Rose Gold Escovado
Cód sem desviador: 110/521/007
Cód com desviador: 111/521/007

Pressão mínima: 2 MCA | Recomendada: a partir de 6 MCA | Pressão máxima: 40 MCA

Vazão 6MCA - 10 lts p/ min.

Square Lux

Chuveiro de Parede e Teto



Chuveiro de Teto Lux.

Chuveiro de Parede Lux.

Preto Fosco
Cód braço de parede: 109/002/003
Cód braço de teto: 109/001/003
Cód ducha (bojo): 109/003/003



Cromado
Cód braço de parede: 109/002/001
Cód braço de teto: 109/001/001
Cód ducha (bojo): 109/003/001



Gold Brilho
Cód braço de parede: 109/002/002
Cód braço de teto: 109/001/002
Cód ducha (bojo): 109/003/002



Rose Gold Brilho
Cód braço de parede: 109/002/004
Cód braço de teto: 109/001/004
Cód ducha (bojo): 109/003/004



Aço Escovado
Cód braço de parede: 109/002/005
Cód braço de teto: 109/001/005
Cód ducha (bojo): 109/003/005



Gold Escovado
Cód braço de parede: 109/002/006
Cód braço de teto: 109/001/006
Cód ducha (bojo): 109/003/006



Rose Gold Escovado
Cód braço de parede: 109/002/007
Cód braço de teto: 109/001/007
Cód ducha (bojo): 109/003/007



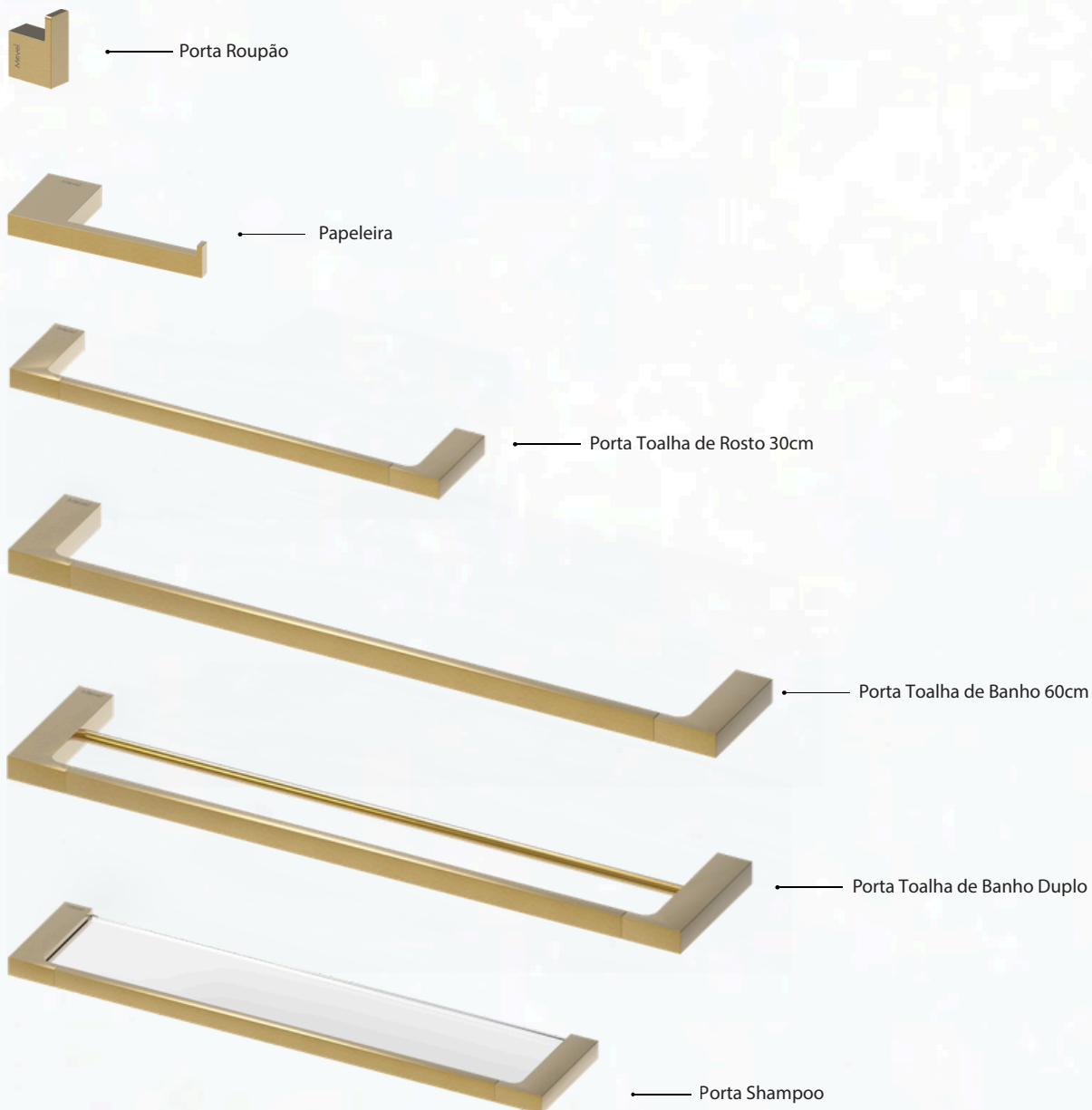

PORTA ROUPÃO

Cód Cromado: 204/008/001
 Cód. Preto Fosco: 204/008/002
 Cód. Gold Brilho: 204/008/003
 Cód. Rose Gold Brilho: 204/008/004
 Cód. Gold Escovado: 204/008/005
 Cód. Aço Escovado: 204/008/006
 Cód. Rose Gold Escovado: 204/008/007



PAPELEIRA

Cód. Cromado: 204/009/001
 Cód. Preto Fosco: 204/009/002
 Cód. Gold Brilho: 204/009/003
 Cód. Rose Gold Brilho: 204/009/004
 Cód. Gold Escovado: 204/009/005
 Cód. Aço Escovado: 204/009/006
 Cód. Rose Gold Escovado: 204/009/007



P. TOALHA DE ROSTO

Cód. Cromado: 204/010/001
 Cód. Preto Fosco: 204/010/002
 Cód. Gold Brilho: 204/010/003
 Cód. Rose Gold Brilho: 204/010/004
 Cód. Gold Escovado: 204/010/005
 Cód. Aço Escovado: 204/010/006
 Cód. Rose Gold Escovado: 204/010/007

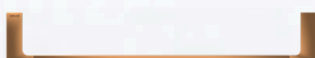

P. TOALHA DE BANHO

Cód. Cromado: 204/011/001
 Cód. Preto Fosco: 204/011/002
 Cód. Gold Brilho: 204/011/003
 Cód. Rose Gold Brilho: 204/011/004
 Cód. Gold Escovado: 204/011/005
 Cód. Aço Escovado: 204/011/006
 Cód. Rose Gold Escovado: 204/011/007



P. TOALHA DE BANHO DUPLO

Cód. Cromado: 204/012/001
 Cód. Preto Fosco: 204/012/002
 Cód. Gold Brilho: 204/012/003
 Cód. Rose Gold Brilho: 204/012/004
 Cód. Gold Escovado: 204/012/005
 Cód. Aço Escovado: 204/012/006
 Cód. Rose Gold Escovado: 204/012/007



P. SHAMPOO

Cód. Cromado: 204/013/001
 Cód. Preto Fosco: 204/013/002
 Cód. Gold Brilho: 204/013/003
 Cód. Rose Gold Brilho: 204/013/004
 Cód. Gold Escovado: 204/013/005
 Cód. Aço Escovado: 204/013/006
 Cód. Rose Gold Escovado: 204/013/007

Evita o acúmulo de sujeira. —

Válvula 1.1/4. —



— Material resistente e durável.

VÁLVULA CLICK 1.1/4 E 7/8



Cromado
Cód Click Lux 1.1/4: 210/501/001



Gold Brilho
Cód Click Lux 1.1/4: 210/501/002



Preto Fosco
Cód Click Lux 1.1/4: 210/501/004



Rose Gold Brilho
Cód Click Lux 1.1/4: 210/501/003



Aço Escovado
Cód Click Lux 1.1/4: 210/501/005



Gold Escovado
Cód Click Lux 1.1/4: 210/501/007



Rose Gold Escovado
Cód Click Lux 1.1/4: 210/501/006

Square Lux



— Modelo Square, com design em formato de cubo.

— Previne vazamentos e o retorno de mau cheiro.

Tamanho Sifão Lux: 40x22,6x4,6cm



Cromado
Cód Lux: 106/501/001



Gold Brilho
Cód Lux: 106/501/004



Preto Fosco
Cód Lux: 106/501/002



Rose Gold Brilho
Cód Lux: 106/501/003



Aço Escovado
Cód Lux: 106/501/007



Gold Escovado
Cód Lux: 106/501/005



Rose Gold Escovado
Cód Lux: 106/501/006

Square Cubo

Acabamento Monocomando de Chuveiro /Registro



- Para Ducha Higiénica Base Deca > Adicionar Conversor : 805/011/001
- Para Registro Monocomando Chuveiro Base Docol de 1/2" Transforme para Base Docol 3/4 > Adicionar Conversor : 805/054/002
- Para Monocomando Chuveiro Base Docol de 1/2" Transforme P/ Base Deca > Adicionar Kit Conversor: 805/002/003



- Controle o seu momento relaxante em um comando.
- Possui Base Deca e Docol 3/4".



Cromado
Cód Base Deca: 122/514/001
Cód Base Docol: 127/514/001



Gold Brilho
Cód Base Deca: 122/514/004
Cód Base Docol: 127/514/004



Rose Gold Brilho
Cód Base Deca: 122/514/003
Cód Base Docol: 127/514/003



Aço Escovado
Cód Base Deca: 122/514/006
Cód Base Docol: 127/514/006



Gold Escovado
Cód Base Deca: 122/514/005
Cód Base Docol: 127/514/005



Rose Gold Escovado
Cód Base Deca: 122/514/007
Cód Base Docol: 127/514/007



Preto Fosco
Cód Base Deca: 122/514/002
Cód Base Docol 3/4": 127/514/002

Square 3/4 Cubo

Acabamento de Registro

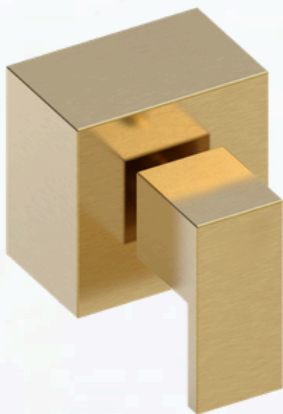

- Para Base Docol > Adicionar Conversor > Cód Conversor Docol: 131623
- Para Base Fabrimar > Adicionar Conversor > Cód Conversor Fabrimar: 132026



- Possui Base Deca.



Cromado 3/4
Cód Deca Cubo: 123/514/001



Gold Brilho 3/4
Cód Deca Cubo: 123/514/004

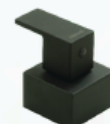

Preto Fosco 3/4
Cód Deca Cubo: 123/514/002



Rose Gold Brilho 3/4
Cód Deca Cubo: 123/514/003



Aço Escovado 3/4
Cód Deca Cubo: 123/514/006



Gold Escovado 3/4
Cód Deca Cubo: 123/514/005



Rose Gold Escovado 3/4
Cód Deca Cubo: 123/514/007

Square / Cubo 1.1/2

Acabamentos Registro 1. 1/2 50mm



— Compatível com base 1.1/2 e 3/4.



Base Deca
Cromado
Cód: 11638610



Base Deca
Aço Escovado
Cód: 11638615



Base Deca
Gold Brilho
Cód: 11638612



Base Deca
Gold Escovado
Cod: 11638614



Base Deca
Preto Fosco
Cód: 11638611



Base Deca
Rose Gold
Cód: 11638613



Base Deca
Rose Gold Escovado
Cód: 11638616

Descarga

Acabamentos Válvula Descarga



— Possui design quadrado, moderno e discreto.

— Compatível com sistemas de válvulas descarga Deca e Docol.



Cromado Deca e Docol
Cód: AHQ2



Aço Escovado Deca e Docol
Cód: AHQ10



Gold Brilho Deca e Docol
Cód: AHQ3



Gold Escovado Deca e Docol
Cód: AHQ5



Preto Fosco Deca e Docol
Cód: AHQ1



Rose Gold Brilho Deca e Docol
Cód: AHQ4



Rose Gold Escovado Deca e Docol
Cód: AHQ6





— Ducha higiênica com acabamento Quadrado

— Comprimento flexível Cubo: 80cm.



Square

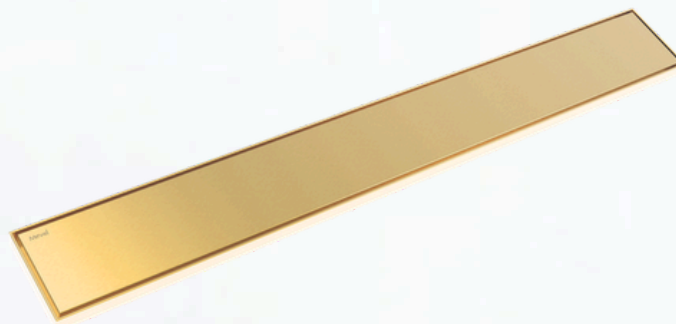

RALO LINEAR COM VÁLVULA DE FECHAMENTO LUX
Tamanho: 80x10x5cm

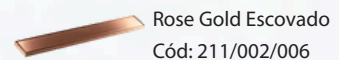
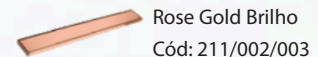
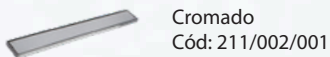

Square 10X10

Ralo Quadrado 10X10



Sistema anti-inseto e anti-odor



Cromado
Cód 10X10 : 211/001/001



Gold Brilho
Cód 10x10 : 211/001/003



Preto Fosco
Cód 10x10 : 211/001/004



Preto Escovado
Cód 10x10 : 211/001/008



Aço Escovado
Cód 10x10 : 211/001/005



Gold Escovado
Cód 10x10 : 211/001/007



Rose Gold Brilho
Cód: 10x10 : 211/001/002



Rose Gold Escovado
Cód 10x10 : 211/001/006

Square 15X15

Ralo Quadrado 15x15



Sistema anti-inseto e anti-odor

- Design moderno.
- Eficaz fluxo de escoamento.
- Conta com grelha interna que protege contra insetos e aumenta o conforto no uso diário, ajudando a reduzir a propagação de odores.



Cromado
Cód 15x15 : 211/519/001



Gold Brilho
Cód 15x15 : 211/519/004



Preto Escovado
Cód 15x15 : 211/519/003



Rose Gold Brilho
Cód 15x15 : 211/519/007



Aço Escovado
Cód 15x15 : 211/519/002



Gold Escovado
Cód 15x15 : 211/519/005



Rose Gold Escovado
Cód 15x15 : 211/519/006



Movel

MOVEL DO BRASIL
Misturador APOLO

Disponível

- **Monocomando** (Quente e Frio)
- **1/4 de Volta** (Somente Água Fria)



Cromado (Misturador)
Cód Bica Alta: 706/530/001
Cód Bica Baixa: 705/530/001

Cromado (1/4 Volta Fria)
Cód Bica Alta: 602/530/001
Cód Bica Baixa: 601/530/001



Gold Brilho (Misturador)
Cód Bica Alta: 706/530/003
Cód Bica Baixa: 705/530/003

Gold Brilho (1/4 Volta Fria)
Cód Bica Alta: 602/530/003
Cód Bica Baixa: 601/530/003



Preto Fosco (Misturador)
Cód Bica Alta: 706/530/002
Cód Bica Baixa: 705/530/002

Preto Fosco (1/4 Volta Fria)
Cód Bica Alta: 602/530/002
Cód Bica Baixa: 601/530/002



Aço Escovado (Misturador)
Cód Bica Alta: 706/530/006
Cód Bica Baixa: 705/530/006

Aço Escovado (1/4 Volta Fria)
Cód Bica Alta: 602/530/006
Cód Bica Baixa: 601/530/006



Gold Escovado (Misturador)
Cód Bica Alta: 706/530/004
Cód Bica Baixa: 705/530/004

Gold Escovado (1/4 Volta Fria)
Cód Bica Alta: 602/530/004
Cód Bica Baixa: 601/530/004



Rose Gold Escovado (Misturador)
Cód Bica Alta: 706/530/005
Cód Bica Baixa: 705/530/005

Rose Gold Escovado (1/4 Volta Fria)
Cód Bica Alta: 602/530/005
Cód Bica Baixa: 601/530/005



Square Paris

Misturadores Monocomando

Design robusto, com linhas retas e precisas.

Opção em bica baixa.

19cm • 20cm • 14cm

26cm • 20cm • 21cm

<p>Cromado Cód Bica Alta: 706/523/001 Cód Bica Baixa: 705/523/001</p>	<p>Gold Brilho Cód Bica Alta: 706/523/003 Cód Bica Baixa: 705/523/003</p>	<p>Preto Fosco Cód Bica Alta: 706/523/002 Cód Bica Baixa: 705/523/002</p>
<p>Aço Escovado Cód Bica Alta: 706/523/007 Cód Bica Baixa: 705/523/007</p>	<p>Gold Escovado Cód Bica Alta: 706/523/004 Cód Bica Baixa: 705/523/004</p>	<p>Rose Gold Brilho Cód Bica Alta: 706/523/005 Cód Bica Baixa: 705/523/005</p>
		<p>Rose Gold Escovado Cód Bica Alta: 706/523/006 Cód Bica Baixa: 705/523/006</p>

Me03

Misturadores Monocomando

16cm • 16cm • 12cm

30cm • 19cm • 25cm

<p>Cromado Cód Bica Alta: 706/003/005 Cód Bica Baixa: 705/003/001</p>	<p>Gold Brilho Cód Bica Alta: 706/003/007 Cód Bica Baixa: 705/003/002</p>	<p>Preto Fosco Cód Bica Alta: 706/003/008 Cód Bica Baixa: 705/003/003</p>
<p>Aço Escovado Cód Bica Alta: 706/003/013 Cód Bica Baixa: 705/003/009</p>	<p>Gold Escovado Cód Bica Alta: 706/003/014 Cód Bica Baixa: 705/003/010</p>	<p>Rose Gold Brilho Cód Bica Alta: 706/003/006 Cód Bica Baixa: 705/003/004</p>

Pressão mínima: 4 MCA | Recomendada: a partir de 6 MCA | Pressão máxima: 40 MCA

Furação 35mm - Pressão - vazão 6MCA - 5 lts p/ min.

Movel



Square Cubo Fria

Torneira De Parede ¼ Volta Água Fria

Produto anexo a parede. →

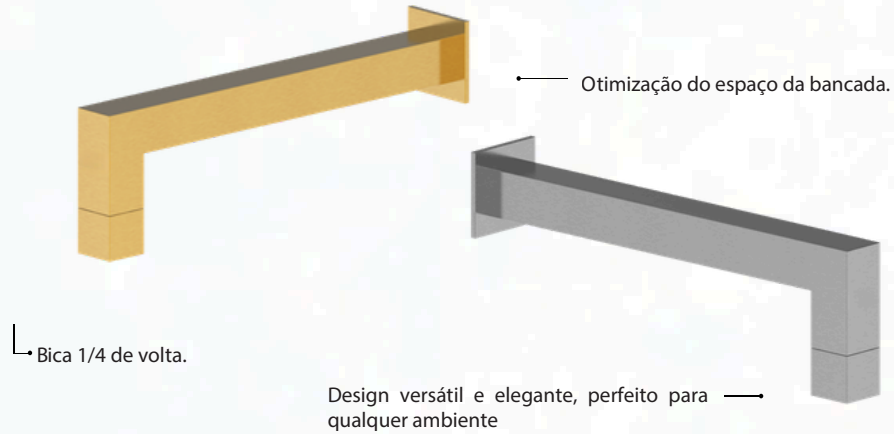

↳ Bica 1/4 de volta.

Design versátil e elegante, perfeito para → qualquer ambiente



25cm • 08cm

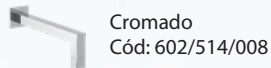

Cromado
Cód: 602/514/008

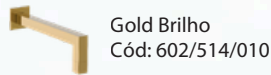

Gold Brilho
Cód: 602/514/010

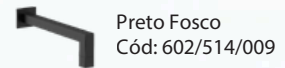

Preto Fosco
Cód: 602/514/009



Aço Escovado
Cód: 602/514/014



Gold Escovado
Cód: 602/514/012

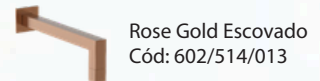

Rose Gold Escovado
Cód: 602/514/013

Square Cubo Fria

Torneira De Bancada ¼ Volta Água Fria

Seu corpo slim, remete a sua → sofisticação, traz ao ambiente um estilo minimalista e moderno

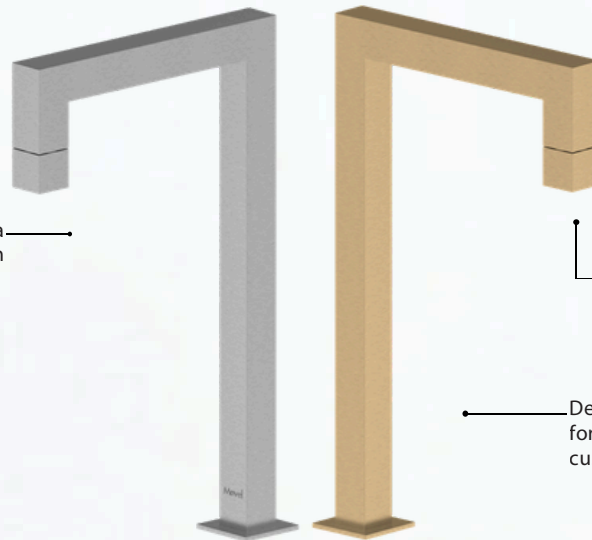

Design geométrico com formas retas e acabamento cubo.



Cromado
Cód Bica Alta: 602/514/001



Gold Brilho
Cód Bica Alta: 602/514/004



Preto Fosco
Cód Bica Alta: 602/514/002



Aço Escovado
Cód Bica Alta: 602/514/007



















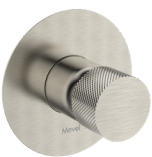

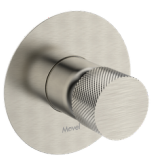

Gold Escovado
Cód Bica Alta: 602/514/005

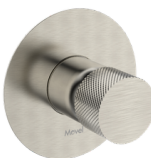

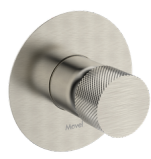
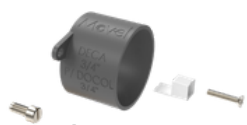
Rose Gold Escovado
Cód Bica Alta: 602/514/006

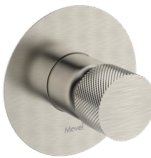
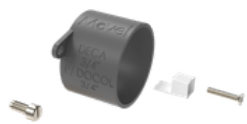

33cm • 20cm • 25cm

BASE INSTALADA:	OPÇÃO 01	ACABAMENTO MOVEL:	OPÇÃO 02	ACABAMENTO MOVEL:
 <p>Registro M. DOCOL 3/4" (Bico Ferro)</p>	<p>Usar Acabamento M. DOCOL 3/4"</p>	 <p>BASE DOCOL 3/4"</p>	-	-
 <p>Registro M. DOCOL 1/2 e 3/4" (Bico Plástico)</p>	<p>Transforme em M. DOCOL 3/4"</p>  <p>Cód: 805/054/002 Conversor P/ Registro Monocomando de Chuveiro 1/2 e 3/4 Docol P/ 3/4 Docol Plástico</p>	 <p>BASE DOCOL 3/4"</p>	<p>Transforme em M. DECA</p>  <p>Cód: 805/054/003 Conversor P/ Registro Monocomando de Chuveiro Docol 1/2 e 3/4 P/ Deca 3/4</p>	 <p>BASE DECA</p>
 <p>Registro M. DOCOL 1/2 e 3/4" <u>Ducha Higiênica</u> (Bico Plástico)</p>	<p>Transforme em M. DOCOL 3/4"</p>  <p>Cód: 805/054/002 Conversor P/ Registro Monocomando de Chuveiro 1/2 e 3/4 Docol P/ 3/4 Docol Plástico</p>	 <p>BASE DOCOL 3/4"</p>	<p>Transforme em M. DECA</p>  <p>Cód: 805/054/003 Conversor P/ Registro Monocomando de Chuveiro Docol 1/2 e 3/4 P/ Deca 3/4</p>	 <p>BASE DECA</p>
 <p>Registro M. MEBER 3/4" (Bico Plástico)</p>	<p>Usar Conversor BASE DECA</p>  <p>Cód: 805/054/004 Conversor P/ Registro Monocomando de Chuveiro Meber P/ Deca Plástico</p>	 <p>BASE DECA</p>	-	-
 <p>Registro M. DECA 3/4" (Bico Plástico)</p>	<p>Usar Acabamento M. DECA 3/4"</p>	 <p>BASE DECA</p>	 <p>Cód: 805/056/001 Conversor P/ Registro Monocomando Chuveiro Base DECA 3/4 P/ Base DOCOL 3/4</p>	 <p>BASE DOCOL 3/4"</p>
 <p>Registro M. DECA 3/4" <u>Ducha Higiênica</u> (Bico Plástico)</p>	<p>Usar Conversor Ducha Higiênica BASE DECA</p>  <p>Cód: 805/011/001 Conversor P/ Registro Monocomando de Ducha Higiênica Deca P/ Chuveiro Deca Plástico</p>	 <p>BASE DECA</p>	 <p>Cód: 805/056/001 Conversor P/ Registro Monocomando Chuveiro Base DECA 3/4 P/ Base DOCOL 3/4</p>	 <p>BASE DOCOL 3/4"</p>

Kit Conversor Para Monocomando De Chuveiro DECA Para DOCOL

Registro M. **DECA 3/4"**
(Bico Plástico)

Com este kit, você adapta sua base de registro monocomando **Deca 3/4"** (bico plástico) para receber acabamentos **Docol 3/4"**



Produto Sob Patente INPI
BR 20 2025 016664 5



Conversor P/ Registro Monocomando Chuveiro
Base DECA 3/4" P/ Base DOCOL 3/4"

Cód: 805/056/001

Acabamento Base
DOCOL 3/4"



Aplicação: base Deca 3/4" → acabamento Docol 3/4"

- Instalação simples – sem quebra de parede
- Economia – aproveita a base existente
- Compatibilidade – ideal para registros de chuveiro
- Design atualizado – utilize acabamentos modernos Docol em instalações Deca

Kit Conversor para Monocomando de Chuveiro 1/2 e 3/4 Docol para Deca

Registro M. **DOCOL**
1/2 e 3/4"
(Bico Plástico)

Com este kit, você adapta sua base de registro monocomando **Docol 1/2 e 3/4"** (bico plástico) para receber acabamentos **Deca 3/4"**



Não funciona para Base DOCOL 3/4"
(Bico de Ferro)

Conversor P/ Registro Monocomando de
Chuveiro Docol 1/2 e 3/4 P/ Deca 3/4"

Cód: 805/054/003

Acabamento Base
DECA 3/4"

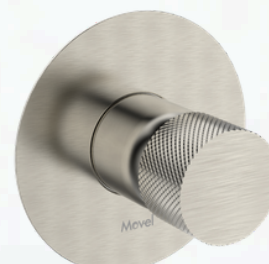

Aplicação: base Docol 1/2 e 3/4" → acabamento Deca 3/4"

- Instalação simples – sem quebra de parede
- Economia – aproveita a base existente
- Compatibilidade – ideal para registros de chuveiro
- Design atualizado – utilize acabamentos modernos Docol em instalações Deca

Toalheiros Elétricos

Toalheiros Elétricos Movel do Brasil unem conforto, praticidade e sofisticação ao banheiro. Com aquecimento eficiente, mantêm as toalhas sempre secas, macias e prontas para uso. O design contemporâneo integra-se com harmonia ao ambiente, enquanto os materiais de alta qualidade garantem durabilidade, resistência e elegância.



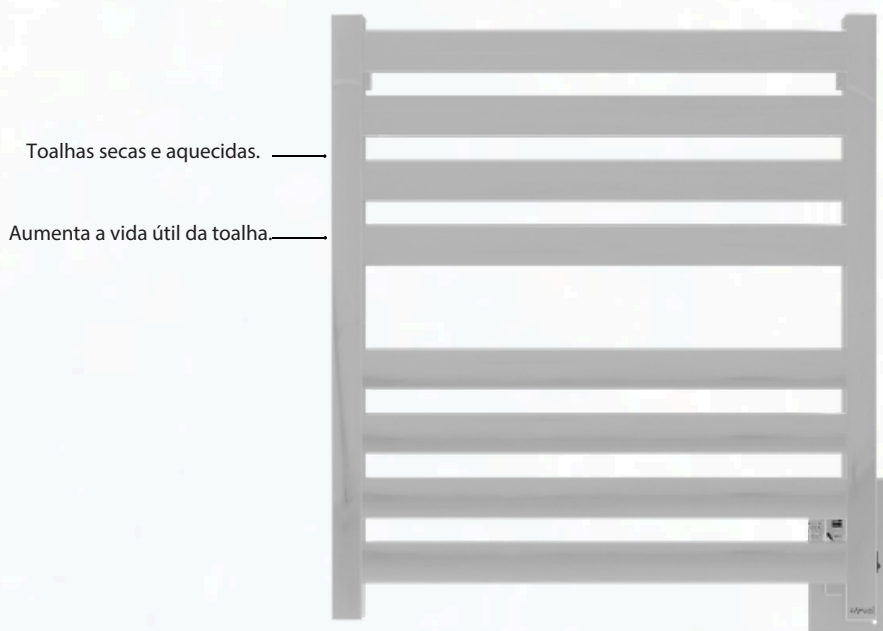

Toalhas secas e aquecidas. —

Aumenta a vida útil da toalha. —

— Temperatura: 35°C acima da temperatura ambiente.

— Ideal para até 04 toalhas de banho.

— Sistema de aquecimento altamente seguro e eficiente.

— Projetado para ficar sempre ligado, o uso contínuo aumenta sua vida útil.

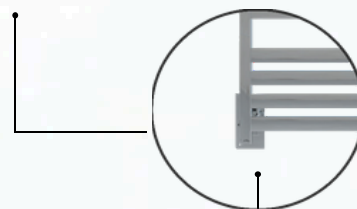

Cabo elétrico oculto personalizado bilateral, na esquerda ou direita.

- Square Clean
- Dimensões: Clean - L: 53 x A:59,5 x C: 9 cm
- 08 barras
- Potência: 100W
- Consumo: 0,1KW/h
- Temperatura: 35°C acima da temperatura ambiente
- Tensão: 110V ou 220V
- Atinge a temperatura ideal em 15 minutos



Preto Aço Carbono
Cód cabo oculto: 204/531/003



Cromado
Cód cabo oculto: 204/531/001

Aço Escovado
Cód cabo oculto: 204/531/008



Gold Brilho
Cód cabo oculto: 204/531/004

Gold Escovado
Cód cabo oculto: 204/531/006



Rose Gold Brilho
Cód cabo oculto: 204/531/005

Rose Gold Escovado
Cód cabo oculto: 204/531/007

Cuba Folha



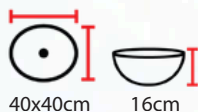

**Cuba De Apoio
MV38 Art**
Gold
Cód: 910/038/002

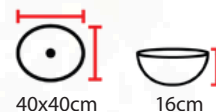

**Cuba De Apoio
MV38 Art**
Rose Gold
Cód: 910/038/001



**Cuba De Apoio
MV45 - Folha Art**
Gold
Cód: 910/045/001

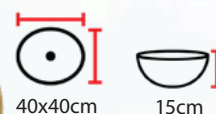

**Cuba De Apoio
MV33 Art**
Gold
Cód: 910/033/001

Rustica

Cuba de Apoio



**Cuba De Apoio
MV35 - Floral**
Marrom
Cód: 910/035/001

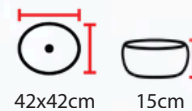

**Cuba De Apoio
MV58 Art**
Marrom
Cód: 910/058/001



**Cuba De Apoio
MV40 - Pedra**
Preto Fosco
Cód: 910/040/001

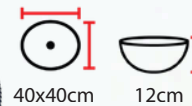

**Cuba De Apoio
MV59 Art**
Azul E Marrom
Cód: 910/059/001

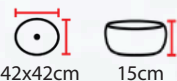

**Cuba De Apoio
MV43 - Pedra**
Preto
Cód: 910/043/001

Cuba MV47





Cuba De Apoio MV10
Branco Brilho
Cód: 910/010/001



Cuba De Apoio MV07
Branco Brilho
Cód: 910/007/001



Cuba De Apoio MV08
Branco Brilho
Cód: 910/008/001



Cuba De Apoio MV17
Branco Brilho
Cód: 910/017/001

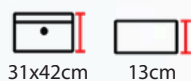

Cuba De Apoio MV24
Branco Brilho
Cód: 910/024/001



Cuba De Apoio MV48 - Slim
Branco Brilho
Cód: 910/048/001



Cuba De Apoio MV47
Branco Brilho
Cód: 910/047/001



Cuba De Apoio MV47
Cinza Fosco
Cód: 910/047/004



Cuba De Apoio MV47
Preto Fosco
Cód: 910/047/003

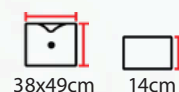

Cuba De Apoio MV16
Branco Brilho
Cód: 910/016/001

MV 31



Quadrada Sem Mesa

Cuba de Apoio

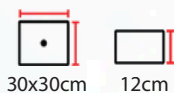

**Cuba De Apoio
MV66**
Branco Brilho
Cód: 910/066/001

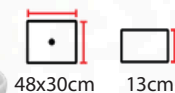

**Cuba De Apoio
MV69**
Branco Brilho
Cód: 910/069/001

Mv31

Cuba de Apoio

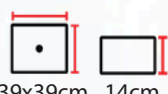

**Cuba De Apoio
MV31**
Branco Brilho
Cód: 910/031/001



**Cuba De Apoio
MV31**
Preto Fosco
Cód: 910/031/006



**Cuba De Apoio
MV31**
Branco C/ Borda
Gold
Cód: 910/031/002



**Cuba De Apoio
MV31**
Branco C/ Borda
Rose Gold
Cód: 910/031/003



**Cuba De Apoio
MV31**
Cinza Fosco
Cód: 910/031/009

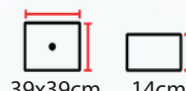

**Cuba De Apoio
MV31**
Branco C/ Borda
Preto Brilho
Cód: 910/031/004





Cuba De Apoio MV37
Branco Brilho
Cód: 910/037/002



Cuba De Apoio MV37 Art
Branco C/ Gold Ext.
Cód: 910/037/003



Cuba De Apoio MV37
Cinza Fosco
Cód: 910/037/006



Cuba De Apoio MV37 Art I
Branco Brilho
Cód: 910/037/001



Cuba De Apoio MV37
Preto Fosco
Cód: 910/037/004



Cuba De Apoio MV37
Branco C/ Borda Gold
Cód: 910/037/011



Cuba De Apoio MV37
Branco C/ Borda Rose Gold
Cód: 910/037/012



Cuba De Apoio MV37
Branco C/ Borda Preto Fosco
Cód: 910/037/013



Redonda com Mesa

Cuba de Apoio



**Cuba De Apoio
MV06**
Branco Brilho
Cód: 910/006/001



**Cuba De Apoio
MV04**
Branco Brilho
Cód: 910/004/001

Redonda sem Mesa

Cuba de Apoio



**Cuba De Apoio
MV01**
Branco Brilho
Cód: 910/001/001



**Cuba De Apoio
MV03 Mini**
Branco Brilho
Cód: 910/333/001



**Cuba De Apoio
MV68**
Branco Brilho
Cód: 910/068/001

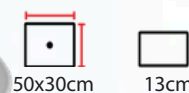

**Cuba De Apoio
MV70**
Branco Brilho
Cód: 910/070/001

Semi Encaixe

Cuba de Apoio



**Cuba De Apoio
MV18 Semiencaixe
S/ Mesa**
Branco Brilho
Cód: 910/018/002



**Cuba De Apoio
MV18 Semiencaixe
C/ Mesa**
Branco Brilho
Cód: 910/018/001



**Cuba De Apoio
MV36 Semiencaixe
C/ Mesa**
Branco Brilho
Cód: 910/036/001





**Cuba De Apoio
Nias Art**
Branco Brilho
Cód: 910/502/001



**Cuba De Apoio
Nias Art**
Branco Fosco
Cód: 910/502/002



**Cuba De Apoio
Nias Art**
Cinza Fosco
Cód: 910/502/003



**Cuba De Apoio
Nias Art**
Preto Fosco
Cód: 910/502/006



**Cuba De Apoio
Nias Art**
Branco C/ Borda
Gold
Cód: 910/502/007



**Cuba De Apoio
Nias Art**
Branco C/ Borda
Preto Fosco
Cód: 910/502/009



**Cuba De Apoio
Nias Art**
Branco C/ Borda
Rose Gold
Cód: 910/502/008

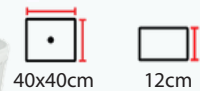

**Cuba De Apoio
Doha Art**
Branco
Cód: 910/507/002



**Cuba De Apoio
Dubai Art**
Branco
Cód: 910/522/001

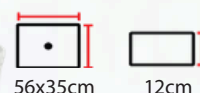

**Cuba De Apoio
Doha Art**
Branco
Cód: 910/507/001



Cuba De Apoio Paris
Cristal
Cód: 910/523/005



Cuba De Apoio Paris
Preto Brilho
Cód: 910/523/001

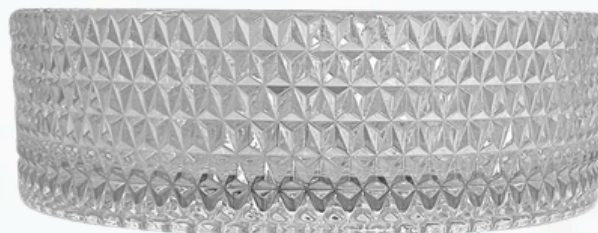

Cuba De Apoio Milão
Cristal
Cód: 910/524/005



Cuba De Apoio Milão
Preto Brilho
Cód: 910/524/001





Quadrada sem Mesa

Cuba de Apoio Válvula Oculta



 43x38cm 14cm
Cuba De Apoio Prisma
 Branco Fosco
 Cód: 910/513/002



 43x38cm 14cm
Cuba De Apoio Prisma
 Branco Brilho
 Cód: 910/513/001



 43x38cm 14cm
Cuba De Apoio Prisma
 Preto Fosco
 Cód: 910/513/006



 43x38cm 14cm
Cuba De Apoio Prisma
 Cinza Fosco
 Cód: 910/513/003



 60x38cm 17cm
Cuba De Apoio Retangular Prisma
 Branco Brilho
 Cód: 910/513/007



Round New Fluir





- | | | | | | |
|--|---|--|--|--|---|
| | New Fluir Branco Brilho
Cód Convencional: 411/533/001 | | New Fluir Branco Fosco
Cód Convencional: 411/533/002 | | New Fluir Branco Fosco
Cód Caixa Acop: 401/533/002 |
| | New Fluir Preto Fosco
Cód Convencional: 411/533/003 | | New Fluir Preto Fosco
Cód Convencional: 411/533/003 | | New Fluir Cinza Fosco
Cód Convencional: 411/533/004 |
| | New Fluir Branco Brilho
Cód Caixa Acop: 401/533/001 | | New Fluir Preto Fosco
Cód Caixa Acop: 401/533/003 | | New Fluir Cinza Fosco
Cód Caixa Acop: 401/533/004 |



Lux Branco Brilho
Cód Convencional: 411/501/001



Lux Preto Fosco
Cód Convencional: 411/501/003



Lux Branco Fosco
Cód Convencional: 411/501/004



Cód Caixa Acop: 401/501/001



Cód Caixa Acop: 401/501/003



Lux Preto Brilho
Cód Convencional: 411/501/002



Bacia Doha

Vaso sanitário robusto, de alto desempenho, com funcionamento eficiente e o melhor custo-benefício do mercado.



Doha Branco Brilho
Cód Caixa Acop: 401/507/001

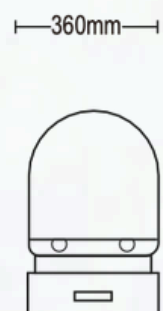
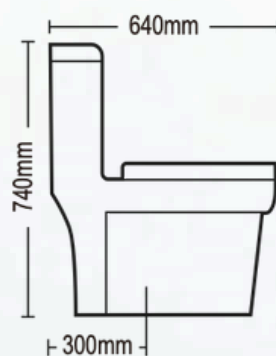

Banheira Nature

Material exclusivo **NatureStone®**

A Banheira Nature une design orgânico, conforto e tecnologia.

Produzida em **NatureStone®**, material composto exclusivo, oferece textura mineral sofisticada, leveza e alta resistência.

Sua superfície não porosa é antiderrapante, anti-risco e anti-manchas, garantindo fácil limpeza e durabilidade.

O **NatureStone®** também proporciona excelente isolamento térmico, mantendo a água aquecida por mais tempo.

Disponível em quatro tonalidades exclusivas, a Nature traduz elegância, bem-estar e desempenho em um único produto.

Diferenciais **NatureStone®**

- **30 anos de Garantia**
- Mantém a temperatura da água por mais tempo
- Leve e de fácil instalação
- Textura mineral exclusiva e antiderrapante
- Superfície anti-risco e anti-manchas
- Não amarela e não perde acabamento
- Alta resistência a impacto
- Superfície não porosa e fácil de limpar

Nature Doha





PESO: 54kg



CAPACIDADE: 280L



Fácil instalação



MATERIAL: NatureStone®



30 Anos de Garantia

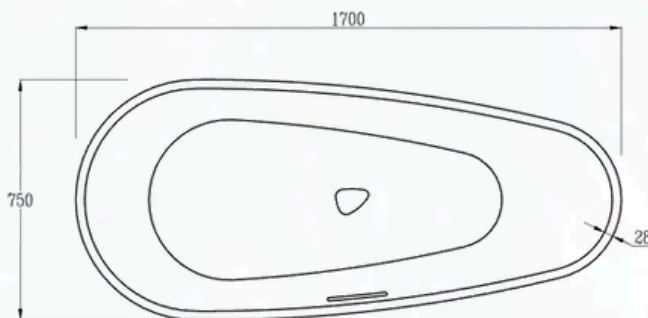
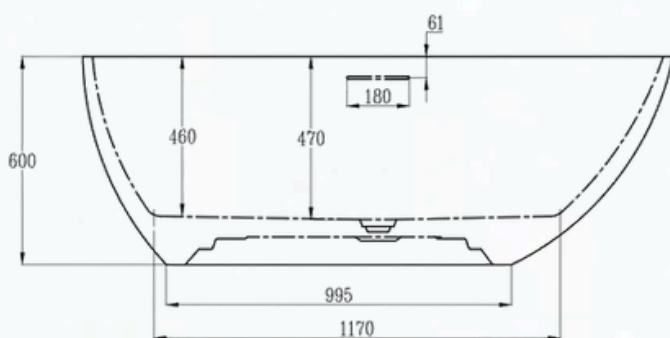

Banheira Nature Doha 1700
Branco Fosco
Cód:906/507/001



Banheira Nature Doha 1700
Areia Nude
Cód:906/507/003



Banheira Nature Doha 1700
Concreto
Cód:906/507/004



Banheira Nature Doha 1700
Preto Fosco
Cód:906/507/002

Nature Round





PESO: 54kg



CAPACIDADE: 280L



Fácil instalação



MATERIAL: NatureStone®



30 Anos de Garantia

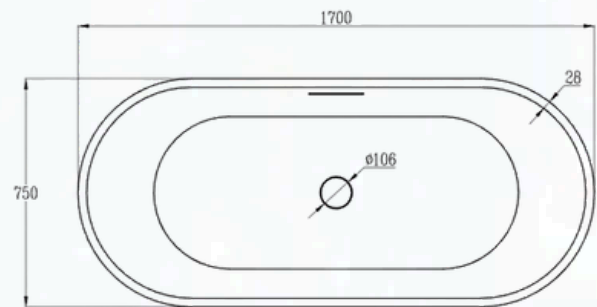
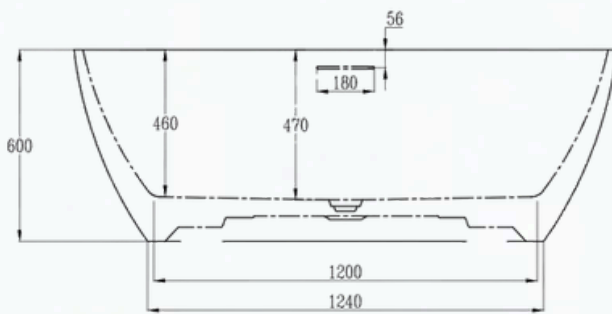

Banheira Nature Round 1700

Branco Fosco
Cód:906/545/001



Banheira Nature Round 1700

Areia Nude
Cód:906/545/003



Banheira Nature Doha 1700

Concreto
Cód:906/545/004



Banheira Nature Round 1700

Preto Fosco
Cód:906/545/002





PESO: 45kg/55kg



CAPACIDADE: 210L/260L



Fácil instalação



MATERIAL: Resina e Acrílico



05 Anos de Garantia

BANHEIRA GALHETA 1500/1700
Branco Brilho



Cód 1500: 906/005/001



67cm



150cm



73cm

Cód 1700: 906/006/001



68cm



170cm



80cm

BANHEIRA ROUND 1500/ 1700
Branco Brilho



ESPECIFICAÇÕES:



PESO: 46kg/54kg



CAPACIDADE: 210L/260L



Fácil instalação



MATERIAL: Resina e Acrílico



05 Anos de Garantia

Cód 1500: 906/003/001



60cm



150cm



70cm

Cód 1700: 906/004/001



60cm



170cm



74cm





Round Art

Banheira Fibra Revestida de Acrílico

BANHEIRA ROUND ART 1500/1700
Branco Brilho

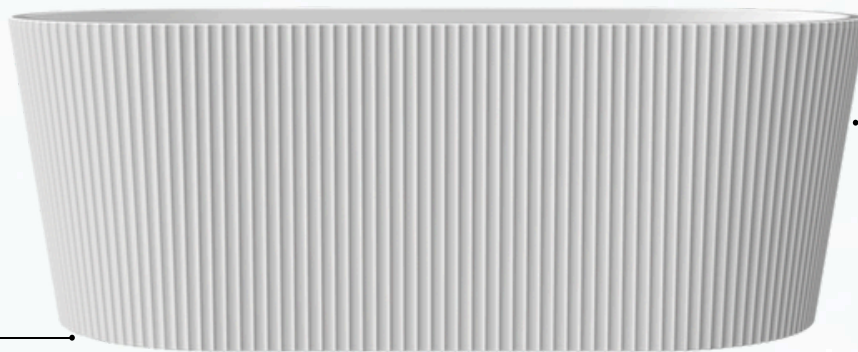

Visual fluído que transmite delicadeza e leveza para o seu ambiente.

Camada de acrílico deixando o produto mais resistente.

Fácil limpeza e manutenção.

MODELO: Nias Art



Design moderno com referências do Art Déco.

Cód 1500: 906/003/002

Cód 1700: 906/004/003



ESPECIFICAÇÕES:



PESO: 48kg/54kg



CAPACIDADE: 210L/260L



Fácil instalação



MATERIAL: Resina e Acrílico



05 Anos de Garantia

Square One 1200

Banheira Fibra Revestida de Acrílico



Banheira Square One 1200

Compacta (1,20 m), ideal para banheiros pequenos. Possui assento integrado, oferecendo mais conforto e diferentes posições para relaxar.



Banheira Square One 1200
Branco Fosco
Cód: 906/525/001



Round / Square

Design minimalista slim, que transmite elegância ao ambiente.

Ducha móvel e flexível de 1,5m.

Misturador de Piso Round.

Misturador de Piso Square.

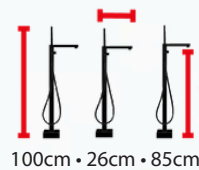

Cromado
Cód Round: 907/502/001
Cód Square: 907/501/001



Aço Escovado
Cód Round: 907/502/007
Cód Square: 907/501/007



Gold Brilho
Cód Round: 907/502/004
Cód Square: 907/501/004



Gold Escovado
Cód Round: 907/502/005
Cód Square: 907/501/005



Preto Fosco
Cód Round: 907/502/002
Cód Square: 907/501/002



Rose Gold
Cód Round: 907/502/003
Cód Square: 907/501/003



Rose Gold Escovado
Cód Round: 907/502/006
Cód Square: 907/501/006

Cozinha

Permita-se viver a melhor experiência.



Praticidade e agilidade no cotidiano.

Design curvilíneo com movimento.

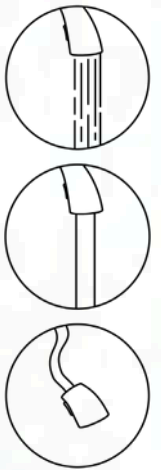

Aço Escovado
Cód: 605/545/001



Gold Escovado
Cód: 605/545/003



Preto Fosco
Cód: 605/545/002



Gunmetal
Cód: 605/545/004

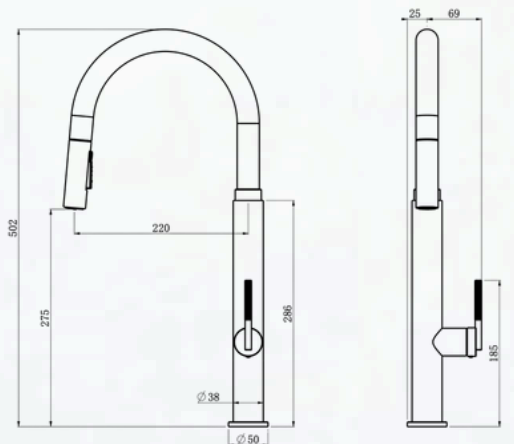



a melhor experiência.

Permita-se vi



Aço Escovado
Cód: 605/546/001



Gold Escovado
Cód: 605/546/003



Preto Fosco
Cód: 605/546/002



Gunmetal
Cód: 605/546/004

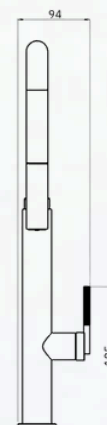
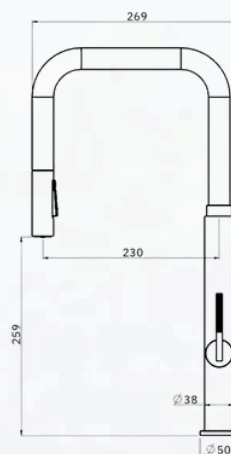



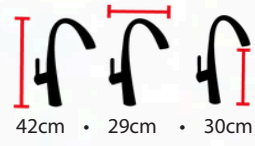
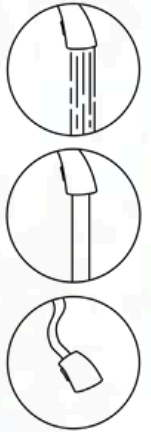

Cromado
Cód: 605/008/001



Gold Brilho
Cód: 605/008/005



Preto Fosco
Cód: 605/008/004



Aço Escovado
Cód: 605/008/003



Rose Gold Brilho
Cód: 605/008/006



Gunmetal
Cód: 605/008/007

Pressão mínima: 8 MCA | Recomendada: a partir de 12 MCA | Pressão máxima: 40 MCA Furação 35mm - Pressão - vazão 12MCA - 5 lts p/ min.



Estética elegante e contemporânea.

Precisão do controle da temperatura.

Bica extensível oferecendo amplitude nos movimentos.

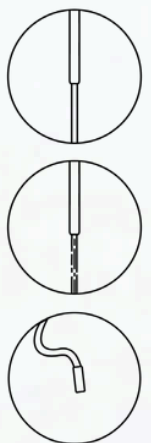

Aço Escovado
Cod: 605/505/002



Design minimalista e delicado.

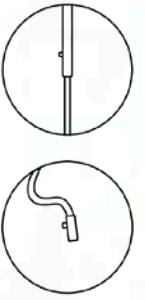

Controle de temperatura e do fluxo de água.

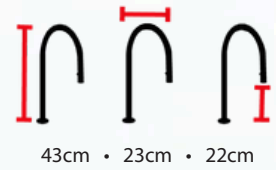

Mel 2 Filtro

**Não acompanha (Filtro).
Vendido separadamente**

Saida Para Água Filtrada

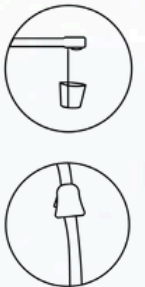

Kit Purificador Fit 200 7 Pol.
Rosca 1/2
Cód : 2010003

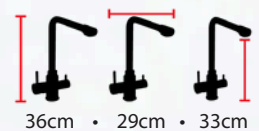



Novel

Slim Filtro

Misturadores Monocomando Gourmet Extensível

MOVEL DO BRASIL

Misturador Gourmet Slim Filtro

Acionamento Água Filtrada



O Gourmet que faz tudo que você precisa.

Água Filtrada na Bica Flexível



Kit Purificador Fit 200 7 Pol.
Rosca 1/2
Cód : 2010003

**Não acompanha (Filtro).
Vendido separadamente**



Aço Escovado
Cód : 605/549/001



Gold Escovado
Cód: 605/549/002



Gunmetal
Cód: 605/549/003

Gravata Filtro

Misturadores Monocomando Gourmet Extensível

**Não acompanha (Filtro).
Vendido separadamente**

Saída giratória com chuveirinho.



Acionamento da água filtrada.



Controle preciso da temperatura.

39cm • 22cm • 31cm



Aço Escovado
Cód: 605/511/001



Kit Purificador Fit 200 7 Pol. Rosca 1/2
Cód: 2010003



Moviel



Kit Purificador

Purificador



Cuba Inox Lux 400
Aço Escovado
Cód: 311/001/001

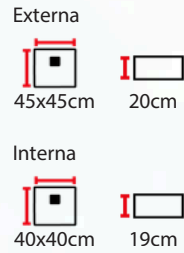
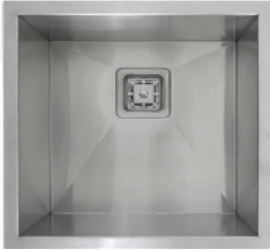

Cuba Inox Lux 500
Aço Escovado
Cód: 311/002/001

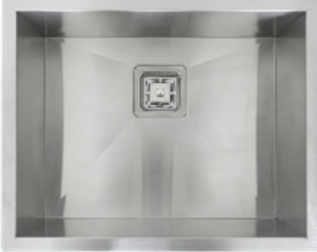

Cuba Inox Lux 500
Gold Escovado
Cód: 311/002/002



Cuba Inox Lux 500
Preto Escovado
Cód: 311/002/004

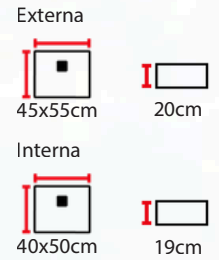
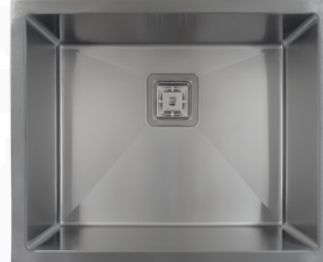

Cuba Inox Lux 600
Aço Escovado
Cód: 311/003/001

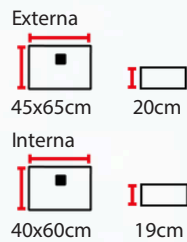
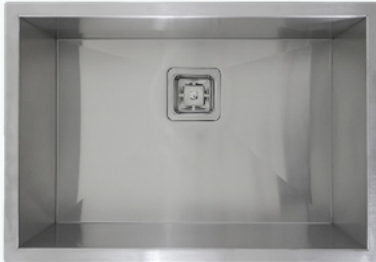

Cuba Dupla Inox Lux 690 c/ Canal Org.
Aço Escovado
Cód: 311/006/001

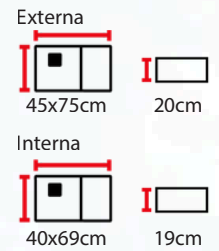

Cuba Inox Lux 700
Aço Escovado
Cód: 311/010/001

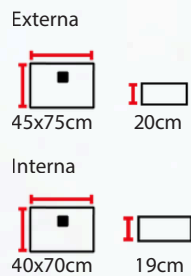
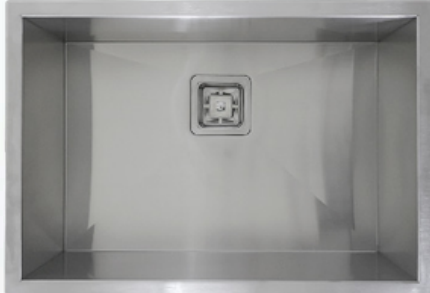

Cuba Dupla Lux 710
Aço Escovado
Cód: 311/005/001

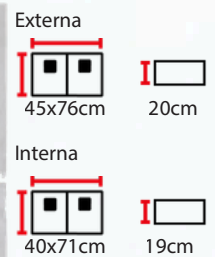
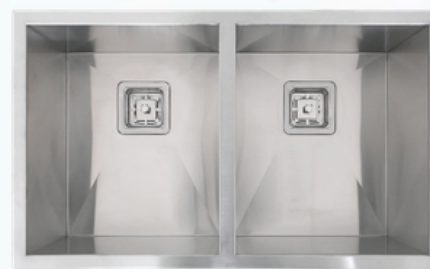

Cuba Lux Fazenda Semi-Encaixe
Aço Escovado
Cód: 311/007/001

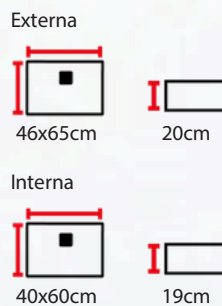

Canal Organizador 450
Cód: 113/001/001



Interna



16,5x45cm



13cm

Externa



19x47,7cm



14cm

Canal Organizador 600
Cód: 113/002/001



Interna



16,5x60,5cm



13cm

Externa



19x63,6cm



14cm

Canal Organizador 900
Aço Escovado
Cód: 113/003/001



Canal Organizador 900
Preto Escovado
Cód: 113/003/004

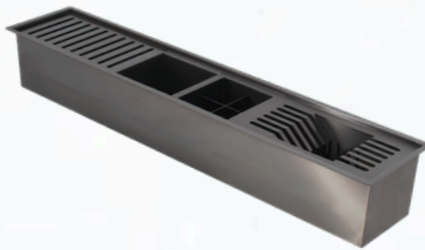

Canal Organizador 900
Gold Escovado
Cód: 113/003/002



Interna



16,5x88,5cm



13cm

Externa



19x91,6cm



14cm

Canal Organizador 1050
Aço Escovado
Cód: 113/004/001



Interna



16,5x104,5cm



13cm

Externa



19x107,6cm



14cm

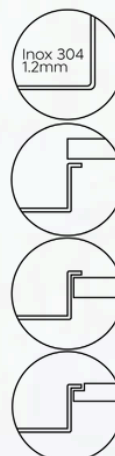



Dosador Round
Aço Escovado
Cód: 310/502/001



Dosador Round
Gold Escovado
Cód: 310/502/002



Dosador Round
Rose Gold Escovado
Cód: 310/502/004



Dosador Round
Preto Fosco
Cód: 310/502/005



Dosador Round
Preto Escovado
Cód: 310/502/003



Dosador Square
Aço Escovado
Cód: 310/501/001



Dosador Square
Gold Escovado
Cód: 310/501/005



Dosador Square
Rose Gold Escovado
Cód: 310/501/006



Dosador Square
Rose Gold Brilho
Cód: 310/501/004



Dosador Square
Preto Fosco
Cód: 310/501/003



Dosador - Doha
Aço Escovado
Cód: 310/507/001

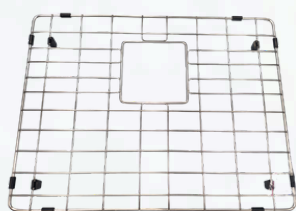

Grade Aramada - Para Cuba 500
Aço Escovado
Cód: 311/009/004

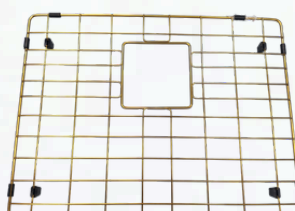

Grade Aramada - Para Cuba 500
Gold Escovado
Cód: 311/009/002

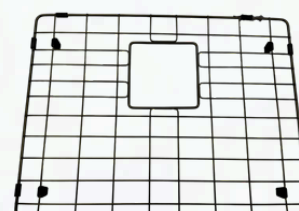

Grade Aramada - Para Cuba 500
Preto Escovado
Cód: 311/009/003

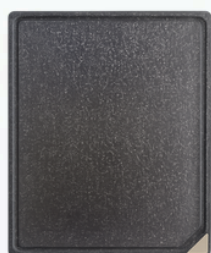

Tábua De Plástico- Para Cubas Square
Cód: 311/011/003



Tábua De Bambu - Para Cubas Square
Cód: 311/010/002



Esteira escorredor Multiuso - Para Cubas Square
Cód: 311/501/005



Lixeira De Embutir - Square 5L
Preto Escovado
Cód: 710/003/001



Lixeira De Embutir - Square 5L
Aço Escovado
Cód: 710/003/002



Lixeira De Embutir - Square 5L
Gold Escovado
Cód: 710/003/003



Lixeira De Embutir -Round 5L
Aço Escovado
Cód: 710/001/001



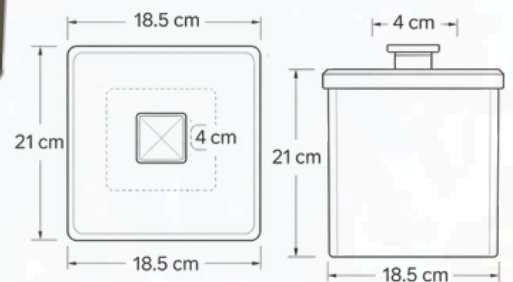

Lixeira Square Com Tampa 5 Litros
Cromado
Product Code: 710/525/002



Lixeira Square Com Tampa 5 Litros
Gold Brilho
Product Code: 710/525/006



Lixeira Square Com Tampa 5 Litros
Preto Fosco
Product Code: 710/525/005



Lixeira Square Com Tampa 5 Litros
Aço Escovado
Cód: 710/525/001



Lixeira Square Com Tampa 5 Litros
Gold Escovado
Cód: 710/525/003



Lixeira Square Com Tampa 5 Litros
Rose Gold Escovado
Cód: 710/525/004



Lixeira Square com Pedal e Balde Removível 40L
Aço escovado
Cód: 710/004/004



40 L

Sistema glazing, um processo que evita que a superfície fique marcada pelo toque das mãos.



Lixeira Square com Pedal e Balde Removível 6l
Preto Fosco
Cod: 710/004/006



Balde interno removível.

Tampa soft close.

Difusor de aroma.

Trava para manter a tampa levantada.



Lixeira Square com Pedal e Balde Removível 6l
Branco Fosco
Cod: 710/004/005

6 L



Lixeira Square com Pedal e Balde Removível 6l
Aço Escovado
Cód: 710/004/001



Lixeira Square com Pedal e Balde Removível 12L
Aço Escovado
Cód: 710/004/002



Lixeira Square com Pedal e Balde Removível 20L
Aço Escovado
Cód: 710/004/003



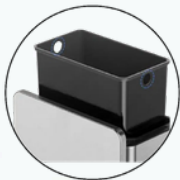

— Sistema prático de remoção do balde para facilitar a manutenção.

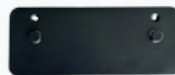

— Suporte para parede, com 3M ou parafuso.



— Suporte para porta/ gaveta de armário.



— Fixação em bancadas com tampa de abertura flexível.

— Sistema glazing, um processo que evita que a superfície fique marcada pelo toque das mãos.



**Lixeira Pendurável – Square
Balde Removível 6L**
Aço Escovado
Cód: 710/005/003



**Lixeira Pendurável – Square
Balde Removível 6L**
Preto Fosco
Cód: 710/005/001



**Lixeira Pendurável – Square
Balde Removível 6L Inox**
Branco Fosco
Cód: 710/005/002



Mevel



Lixeira Square Elétrica com Balde Removível 11L
Branco Fosco
Cod: 710/525/007



Lixeira Square Elétrica com Balde Removível 11L
Preto Fosco
Cod: 710/525/008



Lixeira Square Elétrica com Balde Removível 11L
Aço Escovado
Cod: 710/525/009



Round



Square



Gourmet



Bacias Duplo



Bacia Solo

PAINEIS

SEJA UM LOJA MOVEL, MONTE SEU KIT EXPOSIÇÃO



100
Painel Alto Round 100x184
Branco
Cod: 999/545/004

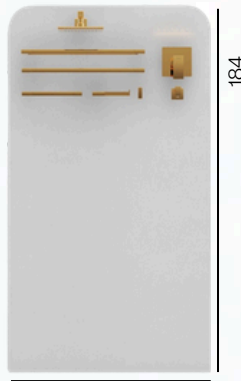

100
Painel Alto Square 100x184
Cinza
Cod: 999/525/001



100
Painel Baixo Round 100x130
Branco
Cod: 999/545/003



185
Painel Baixo Round 185x140
Branco C/ Led
Cod: 999/545/001

MODULOS



100
Modulo Gourmet 100x84
Athena Pérola
Cod: 999/545/005



100
Modulo Cubas 100x84
Athena Pérola
Cod: 999/545/006



100
Modulo Bacias Duplo
Athena Pérola
Cod: 999/545/007



50
Modulo Bacia Solo
Athena Pérola
Cod: 999/545/008



25
Pedestal Round
Cod: 999/545/012



25
Vaso Bali
Cod: 999/545/011



25
Vaso Round
Cod: 999/545/009

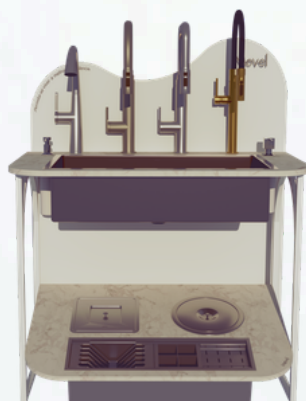

Pecas de Reposicao / Conversores



Assento Sanitário Soft Close Fluir Caixa Acoplada Termofixo Slim
Cód Preto: 702/025/001
Cód Branco: 702/016/001



Assento Sanitário Soft Close Prisma Caixa Acoplada Termofixo Slim
Cód Branco: 702/001/001



Assento Sanitário Soft Close Nias /New Fluir Termofixo Slim
Cód Preto: 702/023/001
Cód Branco: 702/032/001



Assento Sanitário Soft Close Lux Termofixo Slim
Cód Preto: 702/028/001
Cód Branco: 702/029/001

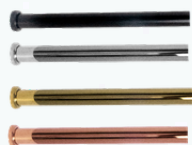

Prolongador de Sifão 30cm
Preto Fosco Cód: 106/805/002
Cromado Cód: 106/805/001
Gold Cód: 106/805/004
Rose Gold Cód: 106/805/003



Kit Reparo Bacias Caixa Acoplada Plástico
Cód: 805/004/001



Mecanismo de Saída Caixa Acoplada Plástico
Cód: 805/003/001



Mecanismo de Entrada Caixa Acoplada Plástico
Cód: 805/002/001



Kit L para Fixação de Bacias Plástico
Cód: 805/001/001



Anel de Vedação para Bacia Sanitária
Cód: 805/009/001



Cartucho Cerâmica para Misturador Monocomando Plástico
Cód: 805/007/001



Adaptador de Válvula 7/8 P/ Sifão 1.1/4 Plástico
Cód: 805/013/001



Adaptador P/ Sifão 4cm Plástico
Cód: 805/012/001

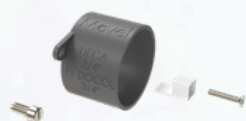

Conversor P/ Registro Monocomando Chuveiro Base DECA 3/4 P/ Base DOCOL 3/4
Cód: 805/056/001



Conversor Para Registro - Docol / Acabamento Deca
Cód. 131623



Conversor Para Registro - Fabrimar / Acabamento Deca
Cód. 132026



Kit Conversor para Monocomando de Chuveiro Deca p/ Ducha Higiênica Deca Plástico
Cód: 805/011/001



Kit Conversor para Monocomando de Chuveiro 1/2 Docol p/ Deca Plástico
Cód: 805/054/003



Conversor para Monocomando de Chuveiro 1/2 e 3/4 Docol para 3/4 Docol (Bico Plástico)
Cód: 805/054/002



Kit Conversor para Monocomando de Chuveiro Meber para Deca Plástico
Cód: 805/054/004

Motor de ímãs permanentes com inversor de frequência
Pós-boiler em nível com tubo pescador

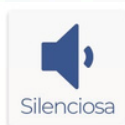

SMART300 • 1/2CV

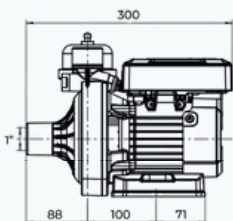

CARACTERÍSTICAS SMART300

Voluta: Plástico reforçado com fibra de vidro
Rotor: Plástico de alta dureza
Eixo: Aço Inox AISI 304
Frequência: 50/60Hz
Rotação máxima: 3000 RPM
Motor com proteção: IP 54
Temperatura máxima do fluido: 80°C
Temperatura ambiente (local instalação): 0°C a 40°C
Pressão máx. na sucção: 30 mca
Pressão de operação: de 10 a 20 mca
Pressão de calibragem do vaso de expansão: 16 PSI

SMART700 • 1CV

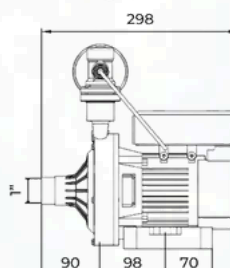

CARACTERÍSTICAS SMART700

Voluta: Aço Inox AISI 304 Fundido
Rotor: Plástico de alta dureza
Eixo: Aço Inox AISI 304
Frequência: 50/60Hz
Rotação máxima: 4000 RPM
Motor com proteção: IP X4
Temperatura máxima do fluido: 80°C
Temperatura ambiente (local instalação): 0°C a 40°C
Pressão máx. na sucção: 30 mca
Pressão de operação: de 10 a 30 mca
Pressão de calibragem do vaso de expansão: 20 PSI
Motor monofásico 220V

CURVA DE DESEMPENHO SMART 300

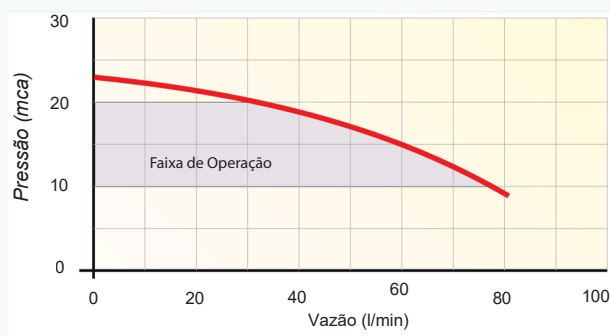

CURVA DE DESEMPENHO SMART 700

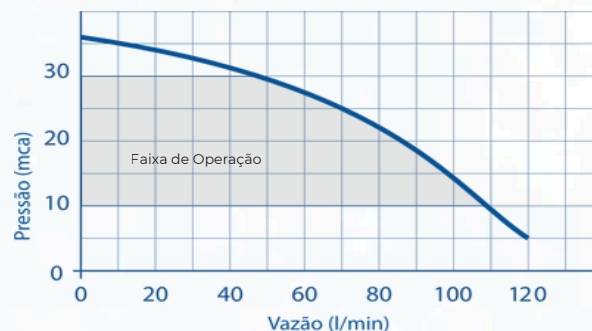

CARACTERÍSTICAS TÉCNICAS

MODELO	POTÊNCIA (CV)	CÓDIGO	TENSÃO (V)	CORRENTE (A)	PRESSÃO MÁX. (mca)	VAZÃO MÁX. (l/min)	CONEXÕES (BSP)		PESO (kg)
							SUC	REC	
SMART-300	1/2	11902	220	4,11	23	81	1"	1"	5,8

MODELO	POTÊNCIA (CV)	CÓDIGO	TENSÃO (V)	CORRENTE (A)	PRESSÃO MÁX. (mca)	VAZÃO MÁX. (l/min) / (m³/h)	CONEXÕES (BSP)	
							SUC	REC
SMART-700	1	12615	220	8,8	36	120 / 7,2	1"	1"

UTILIZE FLEXÍVEIS TEXIUS NA INSTALAÇÃO



FLEXÍVEL PARA AGUA EM INOX
TFLEX-1-60.
Cod: 12552



BOMBA CENTRÍFUGA COM INVERSOR DE FREQ.
SMART300 1/2CV
Cod: 12940



BOMBA CENTRÍFUGA COM INVERSOR FREQ.
SMART 700 1CV
Cod: 12615

- Garantia: 2 anos contra defeito de fabricação.
- A cor do produto pode diferir da cor apresentada no catálogo sem aviso prévio.

Consulte toda linha de acessórios comercializados separadamente.

GARANTIA

- Metais 10 anos;
- Louças Brancas vitalícia;
- Louças Coloridas 05 anos;
- Espelhos 01 ano;
- Cubas Inox 05 anos;
- Cubas de Concreto 01 ano;
- Banheiras Acrílico 05 anos;
- Banheiras Nature 30 anos;
- Peças de Reposição e Mecanismos 01 ano;
- Toalheiro Elétrico 01 ano;



OBSERVAÇÃO

Em caso de mal uso, limpeza incorreta ou utilização de produtos químicos que prejudiquem o produto, perderá automaticamente a garantia.

Kréto
Design

Product Catalog



- "Todos os Objetos que Carregam Nossa Assinatura São Feitos à Mão"

- Nós Criamos Objetos para Viver





Aqui, o design nasce das mãos.

• Escolha sua cor do Concreto

Feitos à mão, com acabamento artesanal e disponíveis em 12 cores para você criar combinações exclusivas



PALETA DE CORES CONCRETO
Cód: 999/529/003

• Metal

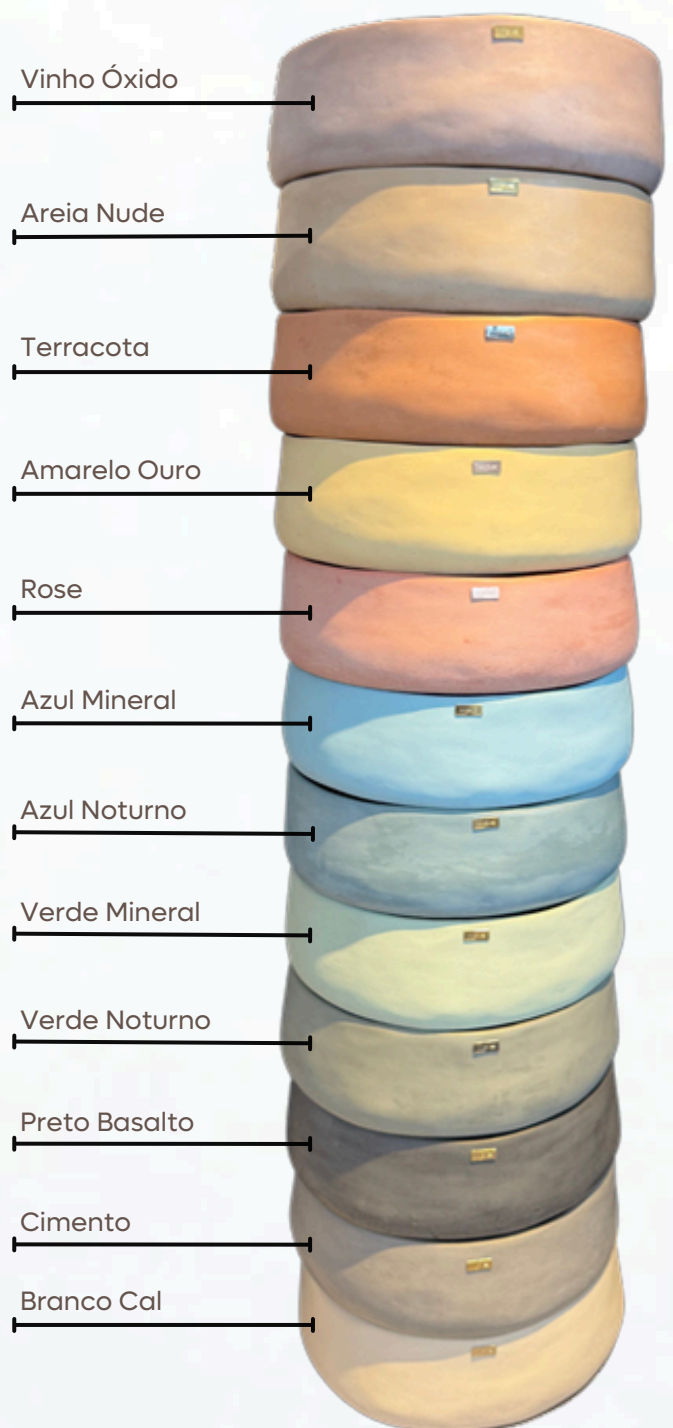

Banheiras de Concreto Modeladas à Mão

Cada banheira é moldada artesanalmente, garantindo exclusividade em cada detalhe. Escolha o modelo, tamanho e cor para um design único, ideal para ambientes internos ou externos. Feitas com concreto de alta performance, unem sofisticação, resistência e autenticidade.

- Banheira Galheta em Concreto



PESO: 165kg/195kg



CAPACIDADE: 210L/260L



Fácil instalação



MATERIAL: Concreto UHPC



01 Ano de Garantia

COLORS



- Tamanhos 1700 e 1500
- Feita em Concreto UHPC
- Mantem a temperatura quente por mais tempo
- Design organico





ESPECIFICAÇÕES:



PESO: 165kg/195kg



CAPACIDADE: 210L/260L



Fácil instalação



MATERIAL: Concreto UHPC



01 Ano de Garantia



Kréto
Design

COLORS



Inspire-se com Nossas Criações



Uma ampla cartela de cores disponível pensando em proporcionar uma experiência única em todo mercado.



Produto artesanal.

Rústica, natural e selvagem.



Cada molde é esculpido à mão, revelando a arte em sua forma mais pura.

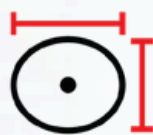

38x38cm



11cm

MOVEL DO BRASIL
Cuba de Concreto Selva



Branco
Cód: 910/544/003



Amarela
Cód: 910/544/004



Terracota
Cód: 910/544/007



Rosa
Cód: 910/544/008



Cinza
Cód: 910/544/001



Azul Claro
Cód: 910/544/005

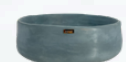

Azul Escuro
Cód: 910/544/00??



Preta
Cód: 910/544/002



Verde Claro
Cód: 910/544/006



Verde Escuro
Cód: 910/544/011



Vinho
Cód: 910/544/012



Marrom Nude
Cód: 910/544/009



Permita-se viver a melhor experiência.

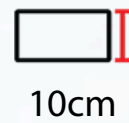

10cm



42x35cm



Branca
Cód: 910/550/003



Cinza
Cód: 910/550/001



Verde Claro
Cód: 910/550/006



Amarela
Cód: 910/550/004



Azul Claro
Cód: 910/550/005



Verde Escuro
Cód: 910/550/011



Terracota
Cód: 910/550/007



Azul Escuro
Cód: 910/550/010



Vinho
Cód: 910/550/012



Rosa
Cód: 910/550/00



Preta
Cód: 910/550/002



Marrom Nude
Cód: 910/550/009



Permita-se viver a melhor experiência.



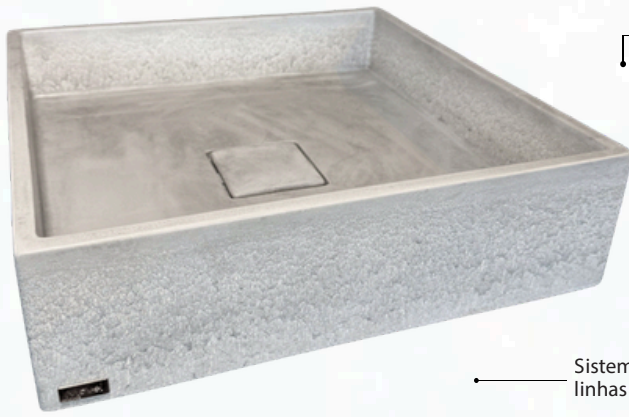

Produto artesanal.

Sistema de válvula oculta, com linhas precisas e escoamento eficaz.

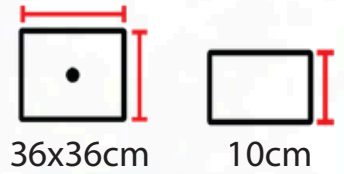

Branca
Cód: 910/538/003



Cinza
Cód: 910/538/001



Verde Claro
Cód: 910/538/006

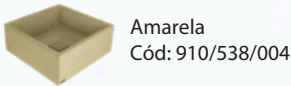

Amarela
Cód: 910/538/004



Azul Claro
Cód: 910/538/005



Verde Escuro
Cód: 910/538/011



Terracota
Cód: 910/538/007



Azul Escuro
Cód: 910/538/010



Vinho
Cód: 910/538/012

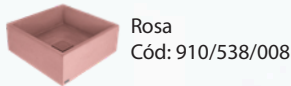

Rosa
Cód: 910/538/008



Preta
Cód: 910/538/002



Marrom
Cód: 910/538/009

Doha



Alta durabilidade ressalta a naturalidade e as características do material com pequenas variações de cores e padrões únicos.

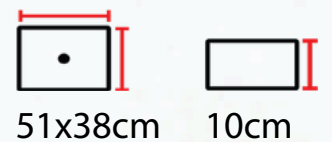

Branco
Cód: 910/507/007



Cinza
Cód: 910/507/005



Verde Claro
Cód: 910/507/010



Amarela
Cód: 910/507/008



Azul Claro
Cód: 910/507/009



Verde Escuro
Cód: 910/507/015



Terracota
Cód: 910/507/011



Azul Escuro
Cód: 910/507/014

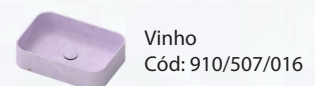

Vinho
Cód: 910/507/016

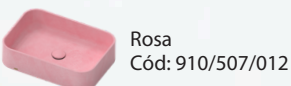

Rosa
Cód: 910/507/012

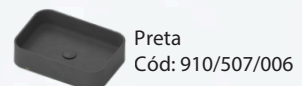

Preta
Cód: 910/507/006



Marrom Nude
Cód: 910/507/013

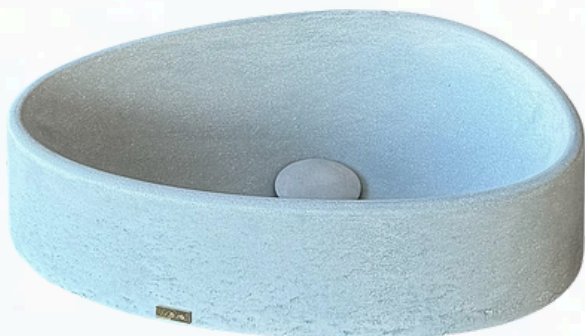

Prozuido em concreto de alta performance (UHPC).

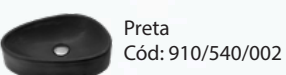
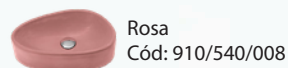
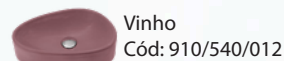
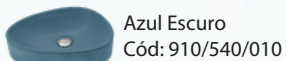
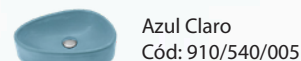
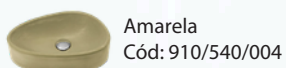
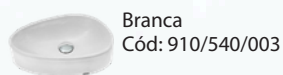
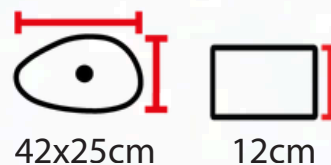

Athena



Sistema de produção sustentável, sem emissão de gases.

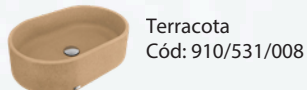
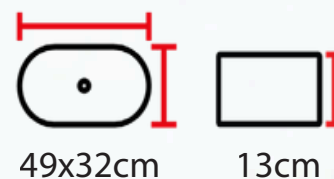



O acabamento acetinado proporciona um toque suave e sofisticado, além de ser produzido em material durável e resistente.

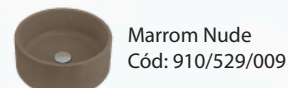
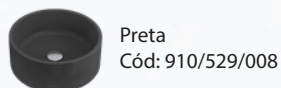
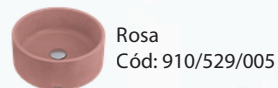
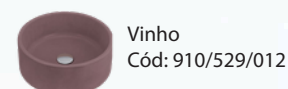
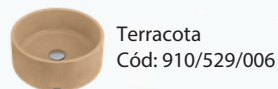
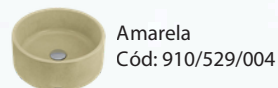
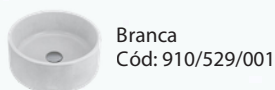
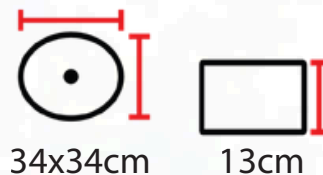

Desenvolvida de forma sustentável, sua produção dispensa o uso de fornos, reduzindo significativamente o consumo de energia.

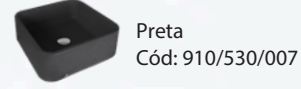
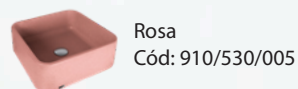
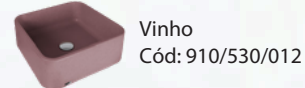
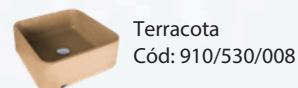
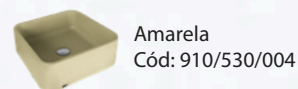
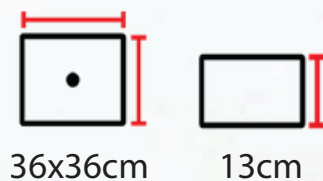





Com seu formato redondo e bordas finas, ela traz delicadeza e fluidez em um produto resistente e robusto.

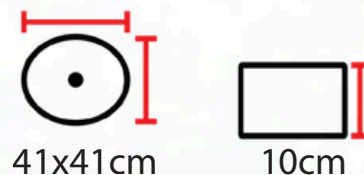

Branca
Cód: 910/537/003



Cinza
Cód: 910/537/001



Verde Claro
Cód: 910/537/006



Amarela
Cód: 910/537/004



Azul Claro
Cód: 910/537/005



Verde Escuro
Cód: 910/537/011



Terracota
Cód: 910/537/007



Azul Escuro
Cód: 910/537/010



Vinho
Cód: 910/537/012



Rosa
Cód: 910/537/008



Preta
Cód: 910/537/002



Marrom
Cód: 910/537/009



Com um visual que combina o robusto com linhas finas, evidencia-se uma peça que pode atender aos mais diversos ambientes.

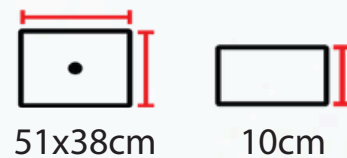

Branco
Cód: 910/536/002



Cinza
Cód: 910/536/001



Verde Claro
Cód: 910/536/006

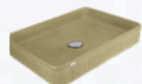

Amarela
Cód: 910/536/004



Azul Claro
Cód: 910/536/005



Verde Escuro
Cód: 910/536/011



Terracota
Cód: 910/536/007



Azul Escuro
Cód: 910/536/010



Vinho
Cód: 910/536/012



Rosa
Cód: 910/536/008



Preta
Cód: 910/536/003



Marrom
Cód: 910/536/009

Cobogo Square

Um sistema modular com três configurações arquitetônicas.

Pilar

Forma vertical que transmite força e equilíbrio. Presença marcante em composições compactas.

Trama

Montagem intercalada que gera profundidade e jogo de luz e sombra. Arquitetura modular com personalidade.

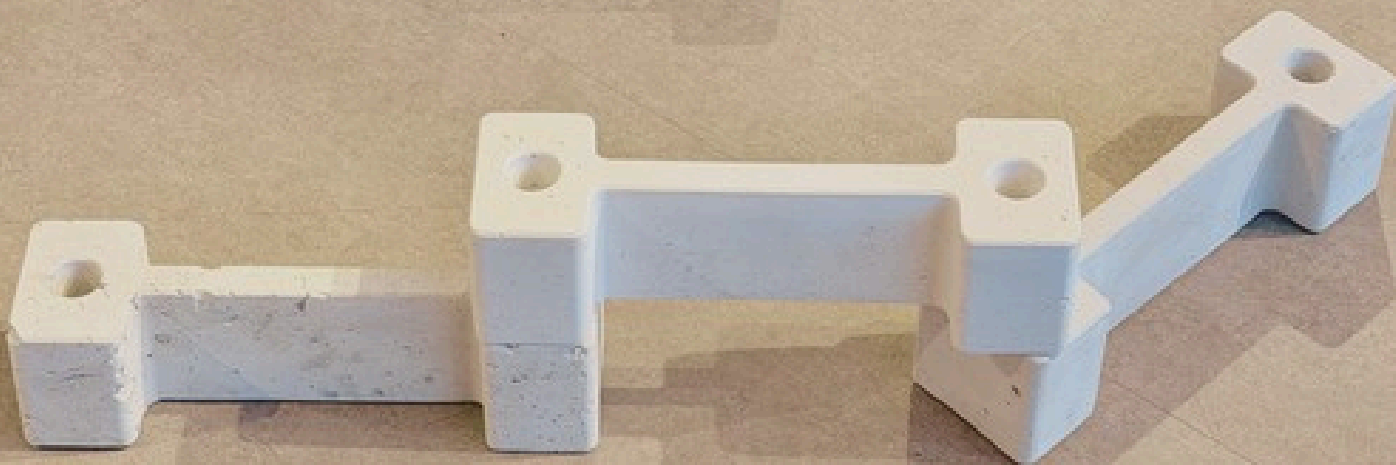
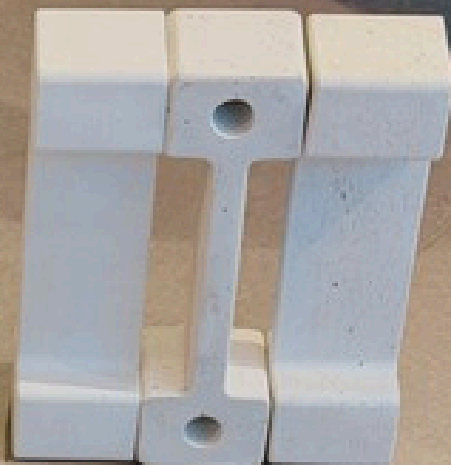
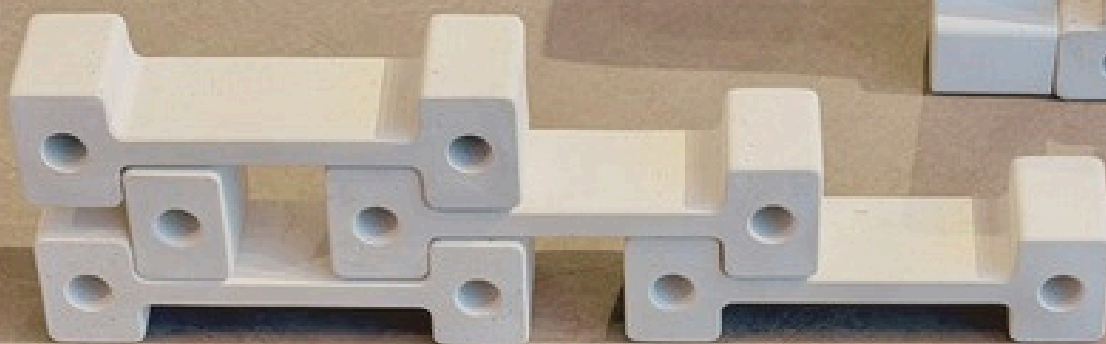

30

Eixo

Composição linear que cria ritmo e continuidade visual. Ideal para divisórias leves e painéis contemporâneos.

8



Cobogó Square
Cod: COBOGO.SQ



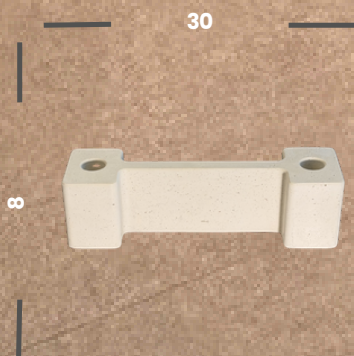
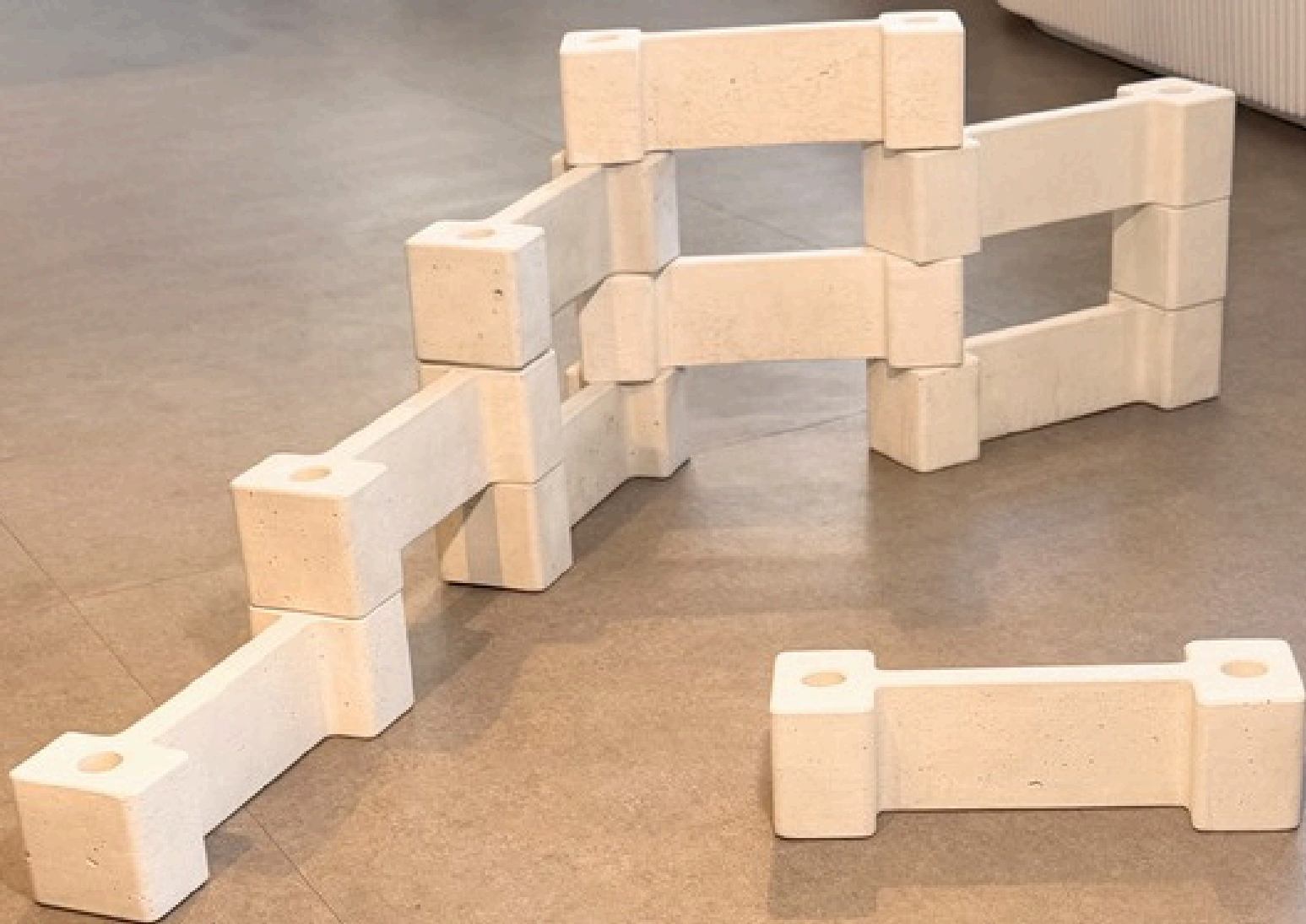

Cobogó Square
Cod:COBOGO.SQ

Inspirado no formato do chapéu de duende, este pendente de concreto feito à mão une design orgânico e minimalista.

Sua presença marcante agrega sofisticação e autenticidade a qualquer ambiente. Produzido em concreto de alta performance (UHPC), combina resistência e elegância em uma só peça atemporal.



Pendente Selva
Cód: P.DU.CO

Altura. 12cm
Largura 40cm
Comprimento do Cabo 2,5 m
Peso 2 kg

Produzido em concreto de alta performance (UHPC), combina resistência e elegância em uma só peça atemporal.
Não acompanha lâmpada.

NOSSAS ARTES



Vela Org
Cód: V.OR.CO



Saboneteira
Cód: S.OR.SE.BR

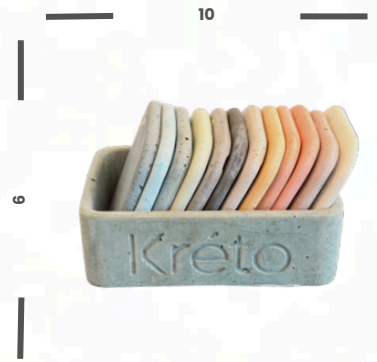

Paleta de Cores
Cód: 999/529/003

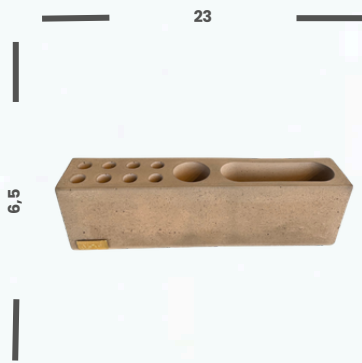

Porta Canetas
Cód: P.CN.BR

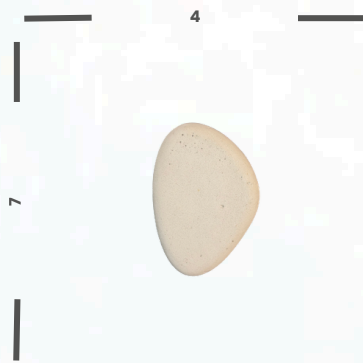

**Cabide de Parede
/Puxador P**
Cód: P.OR.CM



**Cabide de Parede
/Puxador M**
Cód: P.OR.CO

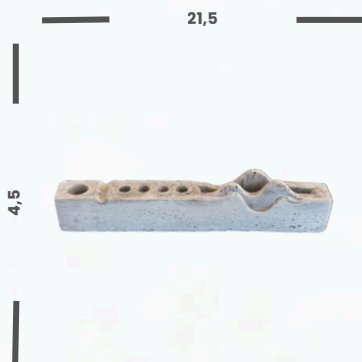

Porta Canetas Slim
Cód: P.S.CN.BR

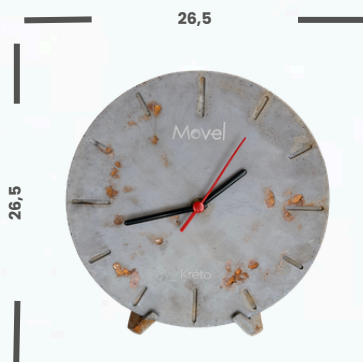

Relógio
Cód: R.OR.CO



Bandeja Org
Cód: B.OR.CO

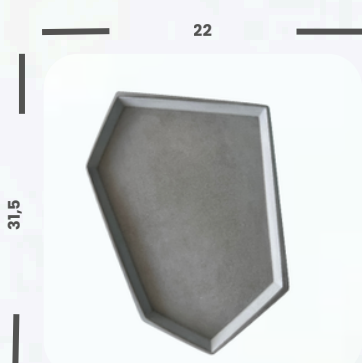

Bandeja Hexagonal
Cód: B.EX.CO



Centro de Mesa
Cód: C.ME.CO

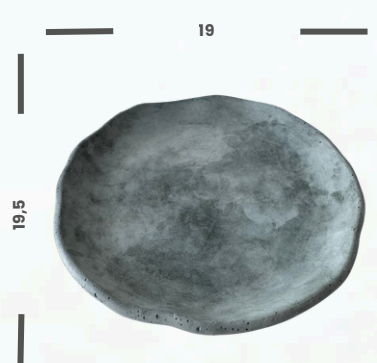

Prato Selva
Cód: P.PE.SE.CO

CORES



CABIDE DE PAREDE / PUXADOR



**Cabide de Parede
/Puxador P
Cód: P.OR.CM**



**Cabide de Parede
/Puxador M
Cód: P.OR.CO**

NOSSOS VASOS



Vaso Cone
Cod: V.CORE



Vaso Round
Cod: 999/545/009



Vaso Bali
Cod: 999/545/011



Vaso Selva
Cod: V.OR.SE.BR



Personalize

Escolha cor, modelo, tamanho e ainda personalize com uma frase, nome ou mensagem gravada a laser.

Inspira-se

É Hora de ser feliz.
O tempo é agora.
Cada segundo importa.
A vida é a arte do encontro.
Faça um bom dia.
Beleza crua da natureza.
Gratidão que transforma.
Viva o agora.
Sonhe alto.
Handmade in Brazil.
Liberdade de criar.
Faça do simples, extraordinário.



Cada detalhe feito à mão.

Kréto
Design



Mesas De Apoio

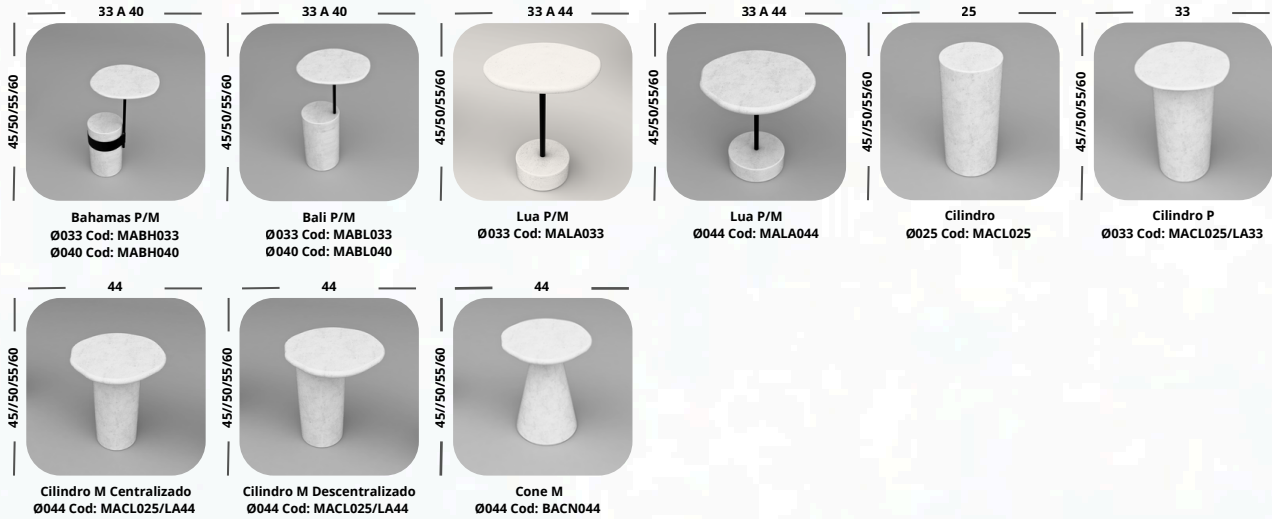

Mesas De Centro

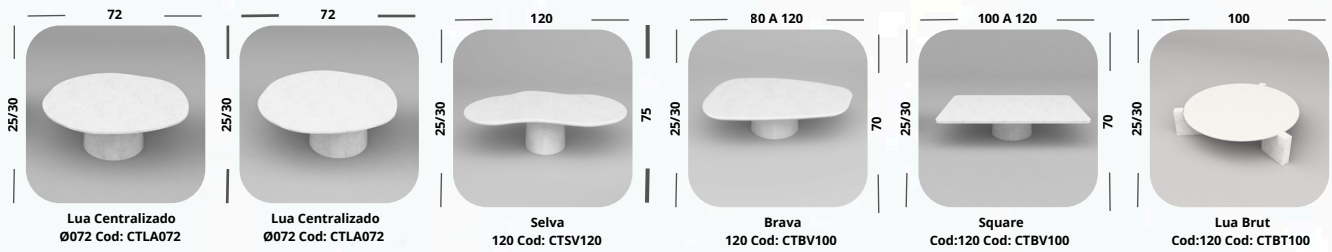

Mesas De Bistro

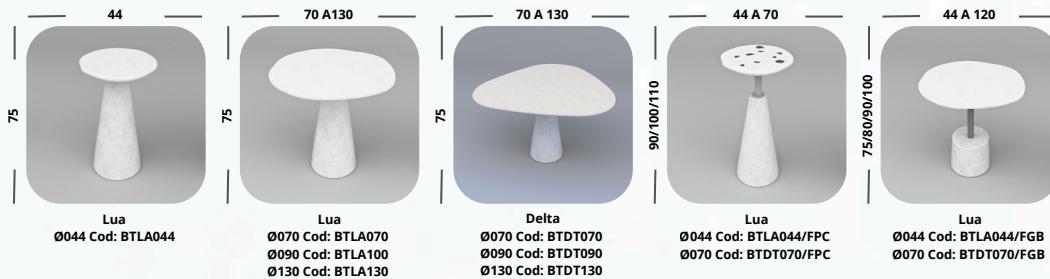

Mesas De Escritorio

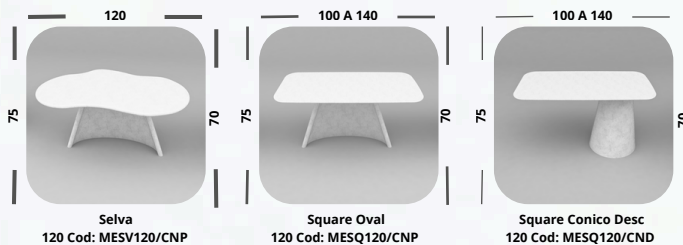

Mesas De Jantar

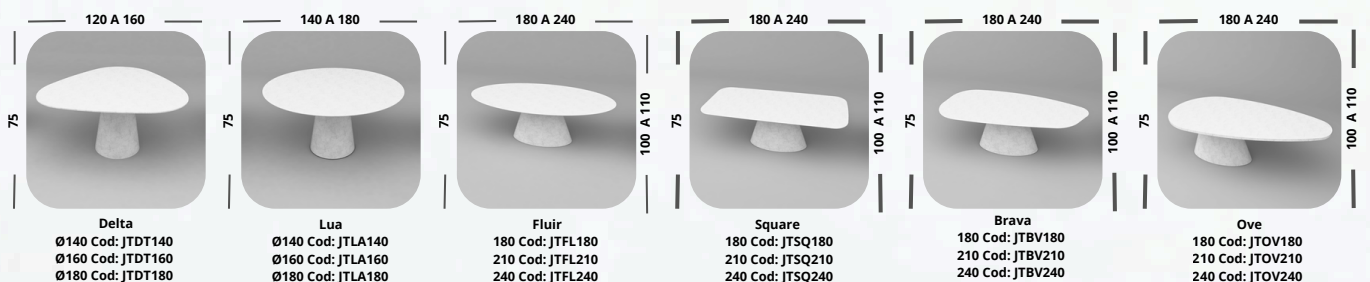

Material

"Feito em concreto UHPC. Perfeito para inside & outside."

Concreto UHPC — resistência e design atemporal
Produzimos nossas peças em UHPC (Ultra High Performance Concrete), um concreto de altíssima resistência, ideal para uso em ambientes internos e externos. Com textura refinada e durabilidade superior, o material permite formas precisas e um acabamento sofisticado. O resultado são produtos únicos, com beleza sólida e performance incomparável.





Movel
do Brasil

SINCE 2012

Kréto
Design

Movel
do Brasil

SINCE 2012

Kréto
Design